

Unit 6  
Ticehurst Yard  
Tostock  
Bury St Edmunds  
Suffolk  
IP30 9PH

Tel: 01359 272 646  
sales@livingwoodwindows.co.uk  
www.livingwoodwindows.co.uk

Unit Type:

LW10  
Double Glazed Timber  
Tilt & Turn Window

Drawing Title:

Section Through Sill  
Opening Sash

Drawing No.:  
LW10-101

Date:  
28/02/13

Drawn By:  
JSE

Scale:  
NTS

This drawing remains the property of Livingwood Windows Ltd and may not be reproduced without written permission. Livingwood Windows Ltd accepts no liability arising from any party acting on information contained within this drawing. It is advised that assistance is sought from Livingwood Windows Ltd regarding matters of an individual project.

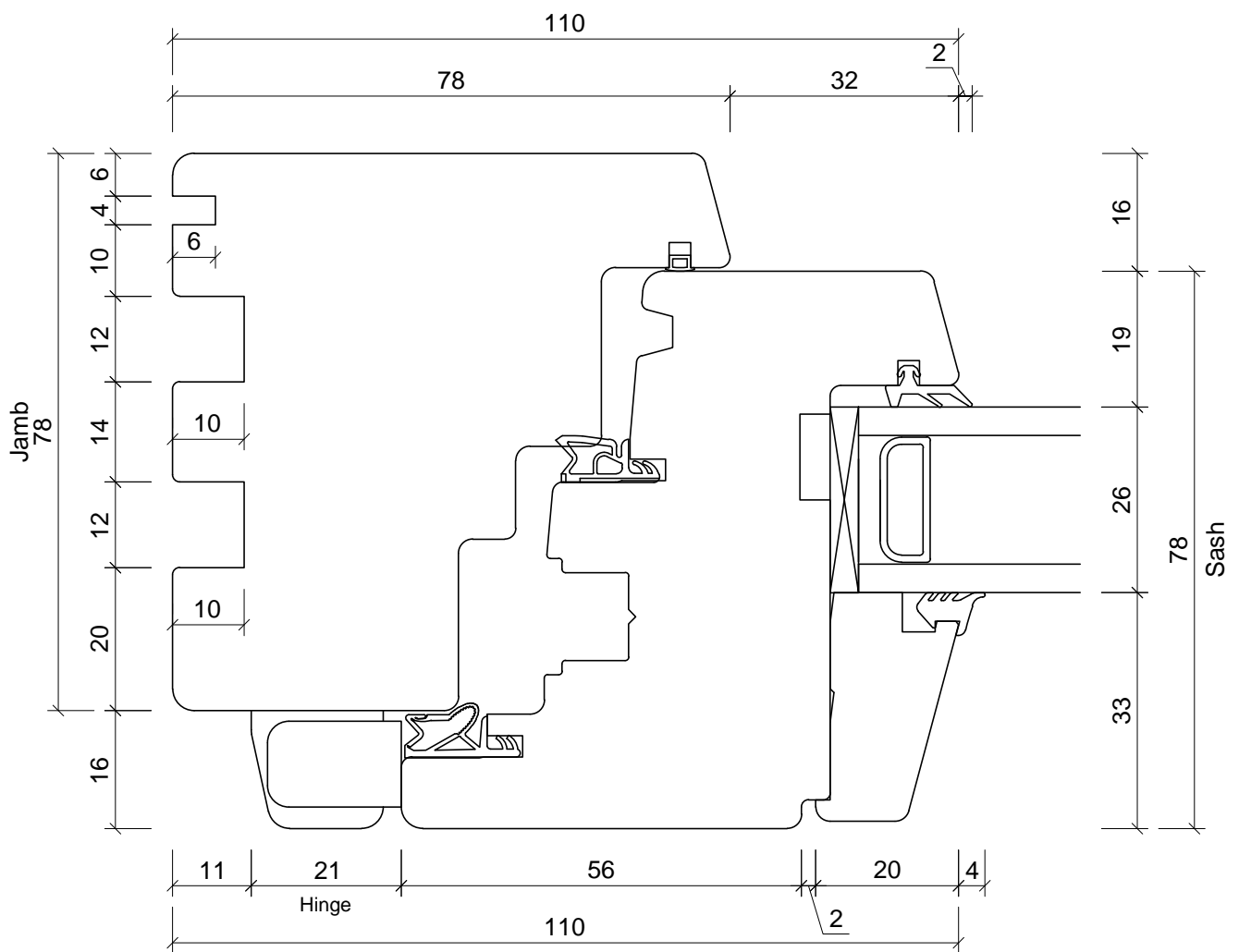
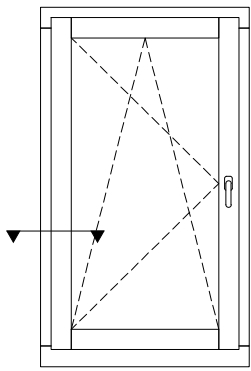

Unit 6  
Ticehurst Yard  
Tostock  
Bury St Edmunds  
Suffolk  
IP30 9PH

Tel: 01359 272 646  
sales@livingwoodwindows.co.uk  
www.livingwoodwindows.co.uk

Unit Type:  
**LW10  
Double Glazed Timber  
Tilt & Turn Window**

Drawing Title:  
**Section Through Jamb  
Opening Sash**

Drawing No.:  
**LW10-102**

Date:  
**28/02/13**

Drawn By:  
**JSE**

Scale:  
**NTS**

This drawing remains the property of Livingwood Windows Ltd and may not be reproduced without written permission. Livingwood Windows Ltd accepts no liability arising from any party acting on information contained within this drawing. It is advised that assistance is sought from Livingwood Windows Ltd regarding matters of an individual project.

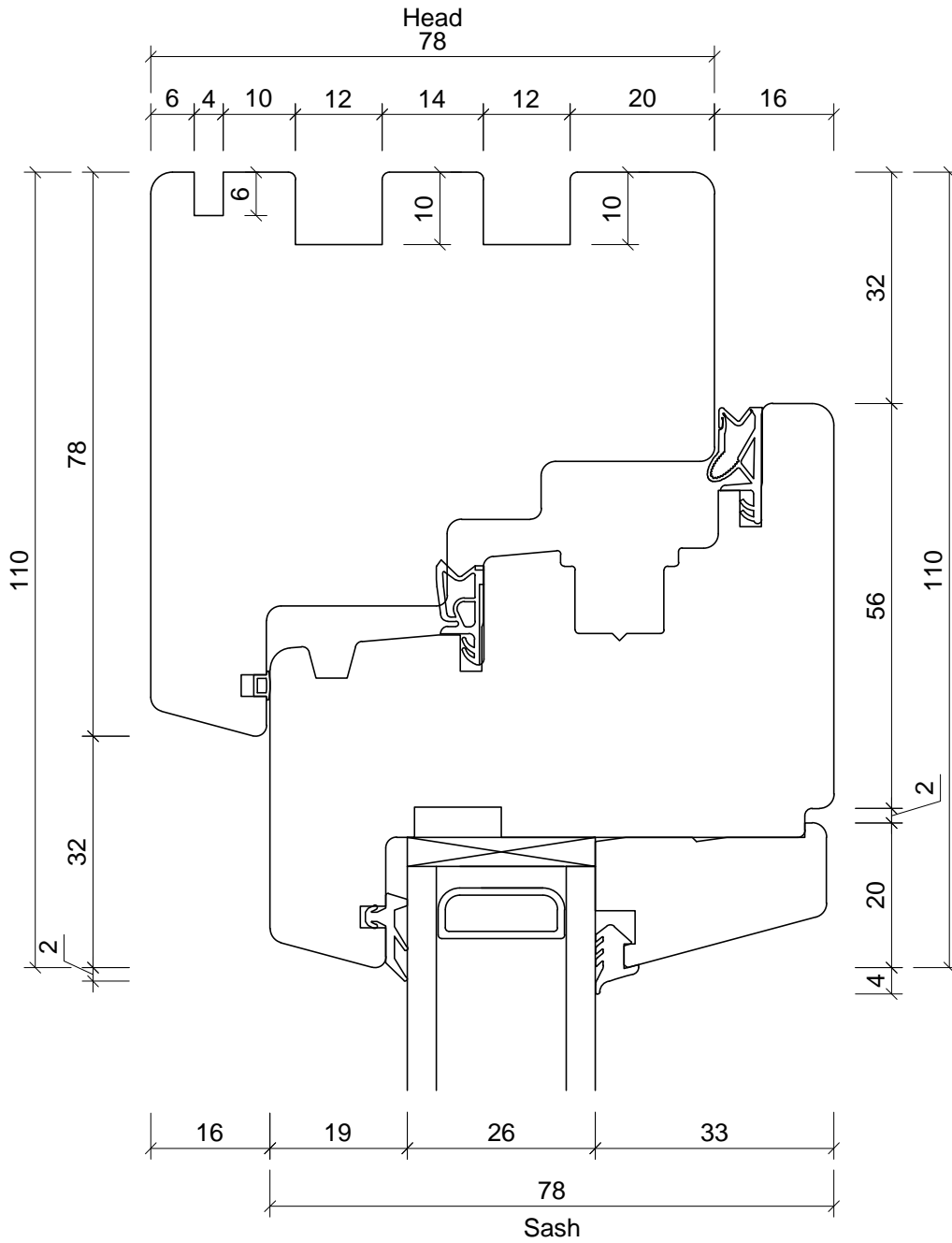
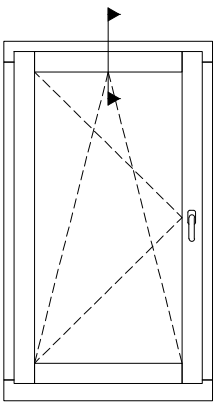

Unit 6  
Ticehurst Yard  
Tostock  
Bury St Edmunds  
Suffolk  
IP30 9PH

Tel: 01359 272 646  
sales@livingwoodwindows.co.uk  
www.livingwoodwindows.co.uk

Unit Type:

LW10  
Double Glazed Timber  
Tilt & Turn Window

Drawing Title:

Section Through Head  
Opening Sash

Drawing No.:  
LW10-103

Date:  
28/02/13

Drawn By:  
JSE

Scale:  
NTS

This drawing remains the property of Livingwood Windows Ltd and may not be reproduced without written permission. Livingwood Windows Ltd accepts no liability arising from any party acting on information contained within this drawing. It is advised that assistance is sought from Livingwood Windows Ltd regarding matters of an individual project.

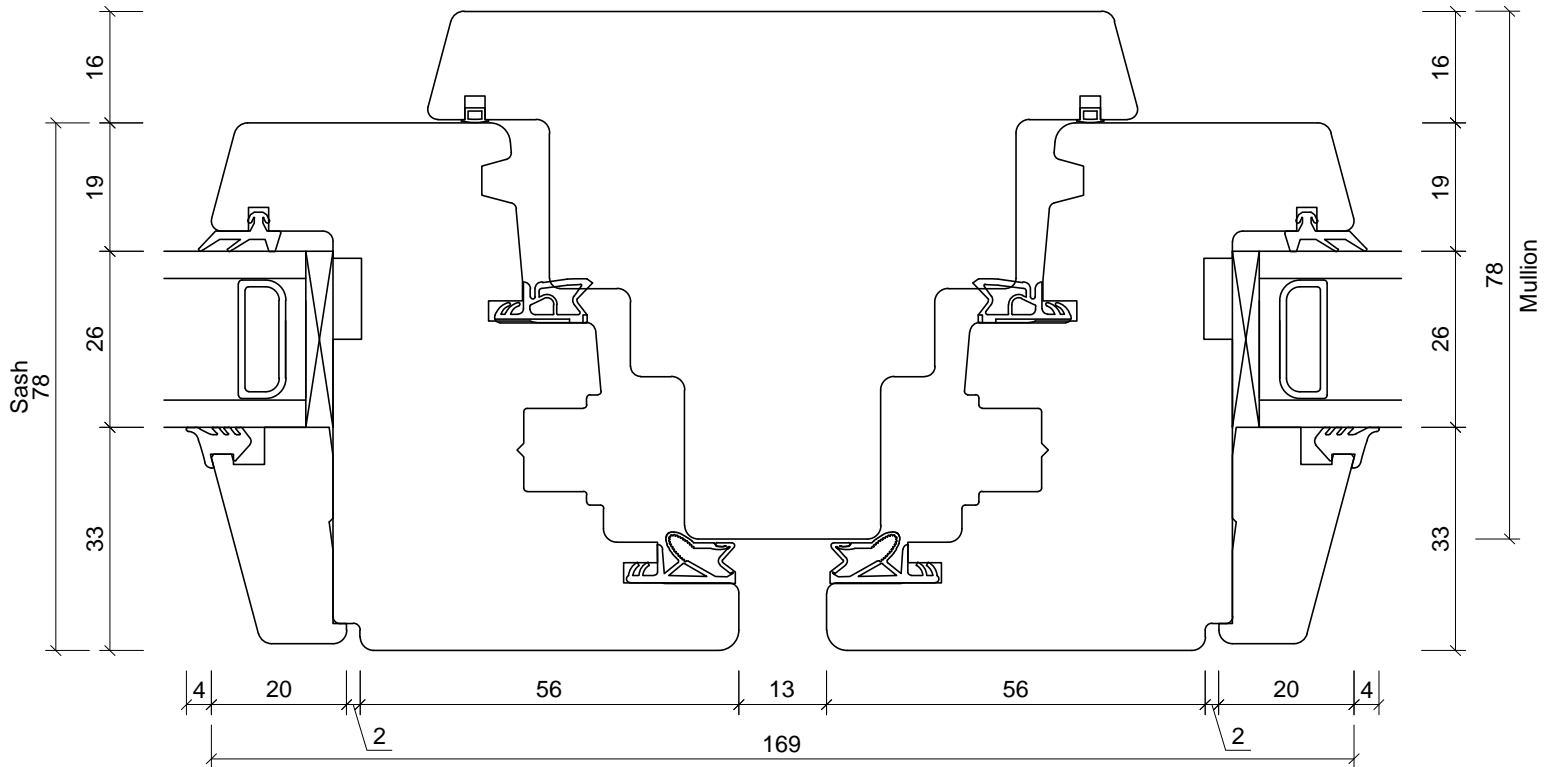
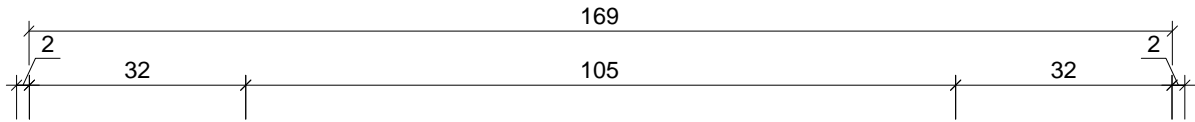
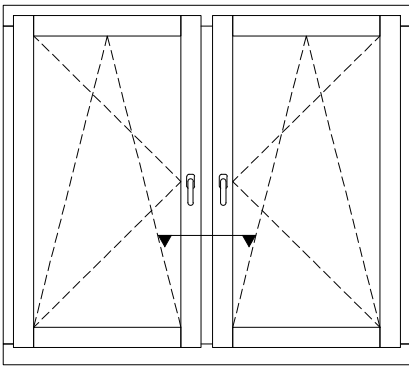

Unit 6  
Ticehurst Yard  
Tostock  
Bury St Edmunds  
Suffolk  
IP30 9PH

Tel: 01359 272 646  
sales@livingwoodwindows.co.uk  
www.livingwoodwindows.co.uk

Unit Type:

LW10  
Double Glazed Timber  
Tilt & Turn Window

Drawing No.:  
LW10-104

Date:  
28/02/13

Drawing Title:

Section Through Fixed Mullion  
Opening Sash/Opening Sash

Drawn By:  
JSE

Scale:  
NTS

This drawing remains the property of Livingwood Windows Ltd and may not be reproduced without written permission. Livingwood Windows Ltd accepts no liability arising from any party acting on information contained within this drawing. It is advised that assistance is sought from Livingwood Windows Ltd regarding matters of an individual project.

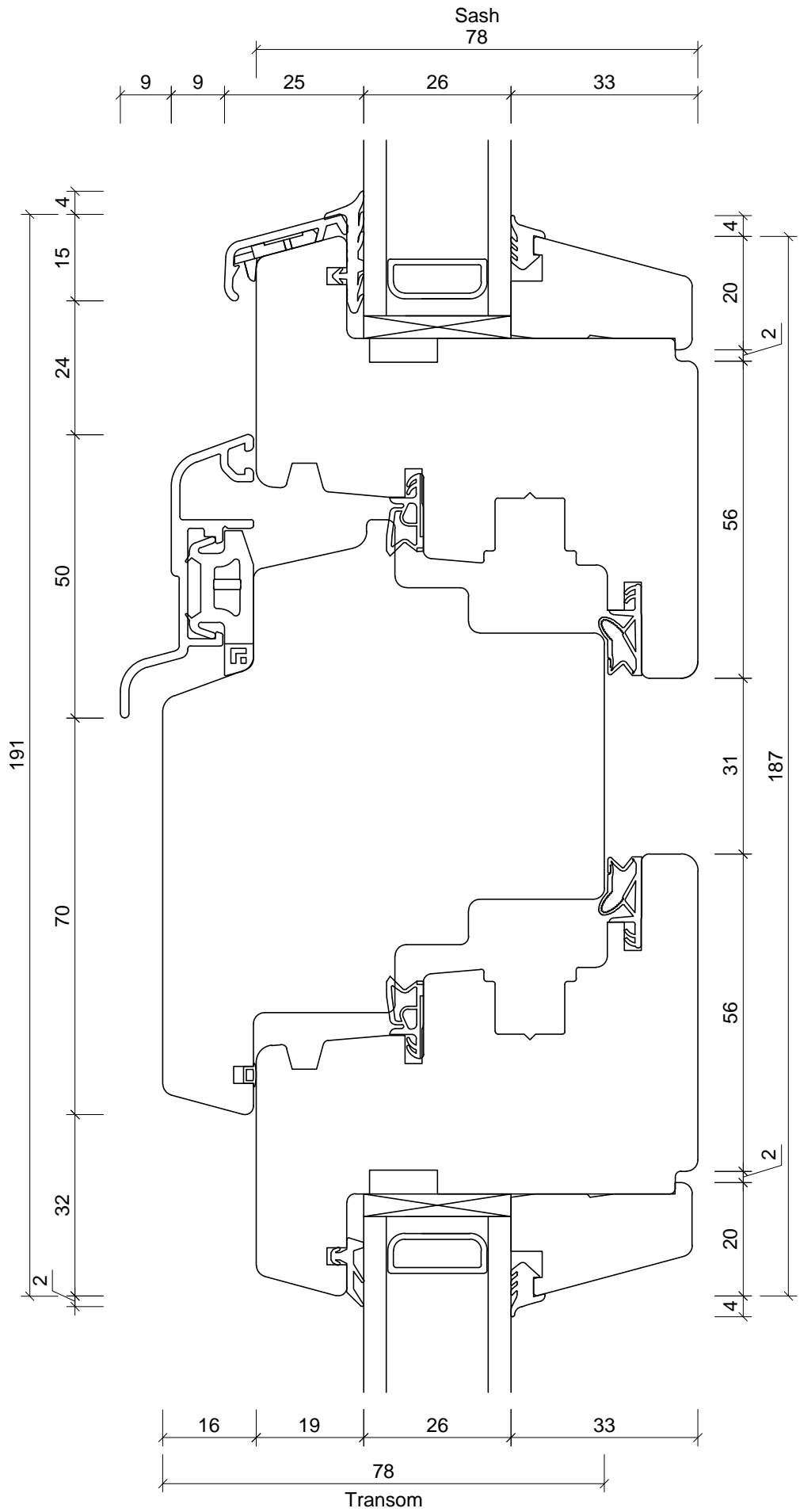
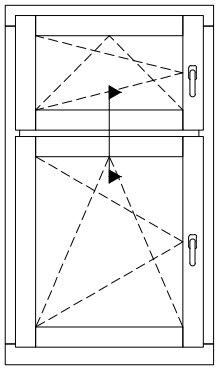

Unit 6  
Ticehurst Yard  
Tostock  
Bury St Edmunds  
Suffolk  
IP30 9PH

Tel: 01359 272 646  
sales@livingwoodwindows.co.uk  
www.livingwoodwindows.co.uk

Unit Type:

LW10  
Double Glazed Timber  
Tilt & Turn Window

Drawing Title:

Section Through Transom  
Opening Sash/Opening Sash

Drawing No.:  
LW10-105

Date:  
28/02/13

Drawn By:  
JSE

Scale:  
NTS

This drawing remains the property of Livingwood Windows Ltd and may not be reproduced without written permission. Livingwood Windows Ltd accepts no liability arising from any party acting on information contained within this drawing. It is advised that assistance is sought from Livingwood Windows Ltd regarding matters of an individual project.

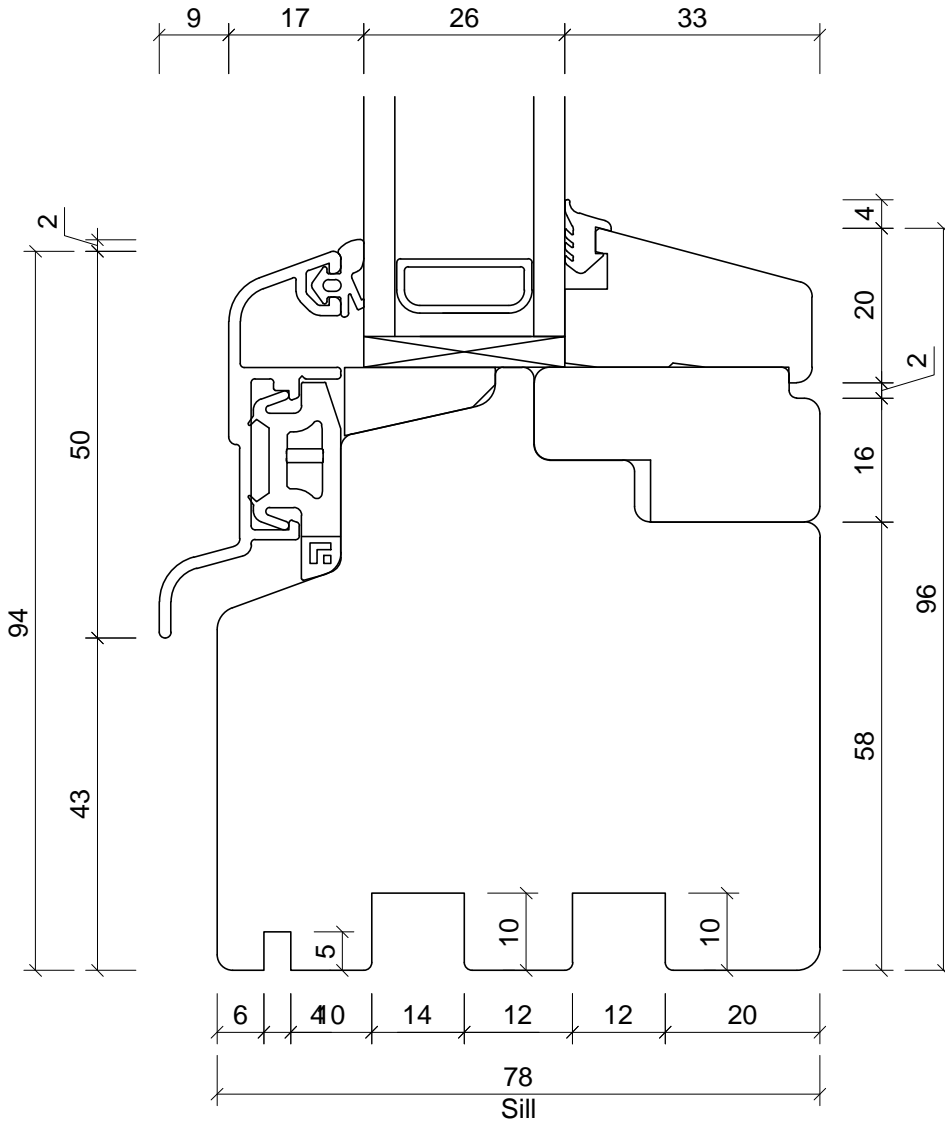
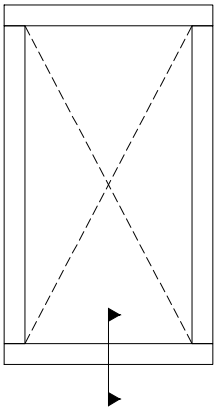

Unit 6  
Ticehurst Yard  
Tostock  
Bury St Edmunds  
Suffolk  
IP30 9PH

Tel: 01359 272 646  
sales@livingwoodwindows.co.uk  
www.livingwoodwindows.co.uk

Unit Type:  
LW10  
Double Glazed Timber  
Tilt & Turn Window

Drawing Title:  
Section Through Sill  
Fixed Light

Drawing No.:  
LW10-106

Date:  
28/02/13

Drawn By:  
JSE

Scale:  
NTS

This drawing remains the property of Livingwood Windows Ltd and may not be reproduced without written permission. Livingwood Windows Ltd accepts no liability arising from any party acting on information contained within this drawing. It is advised that assistance is sought from Livingwood Windows Ltd regarding matters of an individual project.

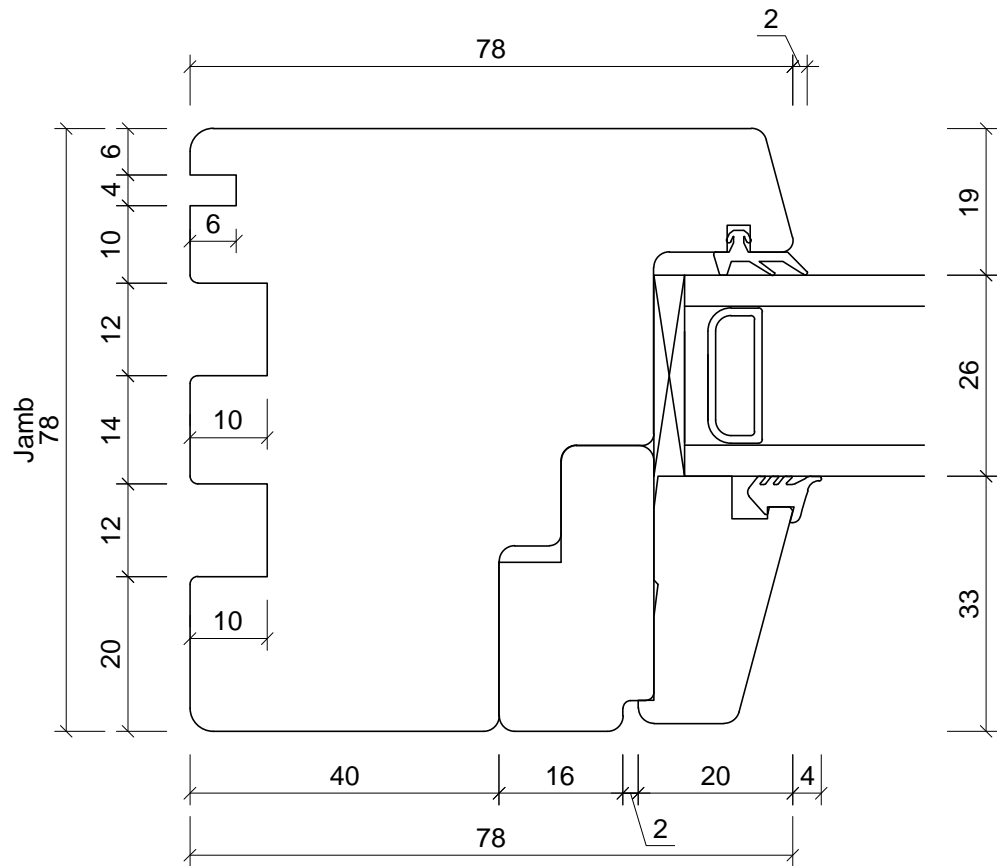
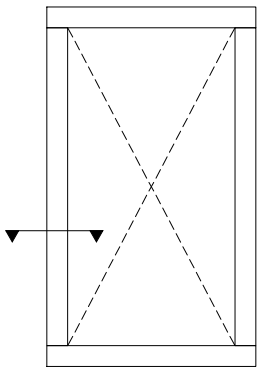

Unit 6  
Ticehurst Yard  
Tostock  
Bury St Edmunds  
Suffolk  
IP30 9PH

Tel: 01359 272 646  
sales@livingwoodwindows.co.uk  
www.livingwoodwindows.co.uk

Unit Type:

LW10  
Double Glazed Timber  
Tilt & Turn Window

Drawing Title:

Section Through Jamb  
Fixed Light

Drawing No.:  
LW10-107

Date:  
28/02/13

Drawn By:  
JSE

Scale:  
NTS

This drawing remains the property of Livingwood Windows Ltd and may not be reproduced without written permission. Livingwood Windows Ltd accepts no liability arising from any party acting on information contained within this drawing. It is advised that assistance is sought from Livingwood Windows Ltd regarding matters of an individual project.

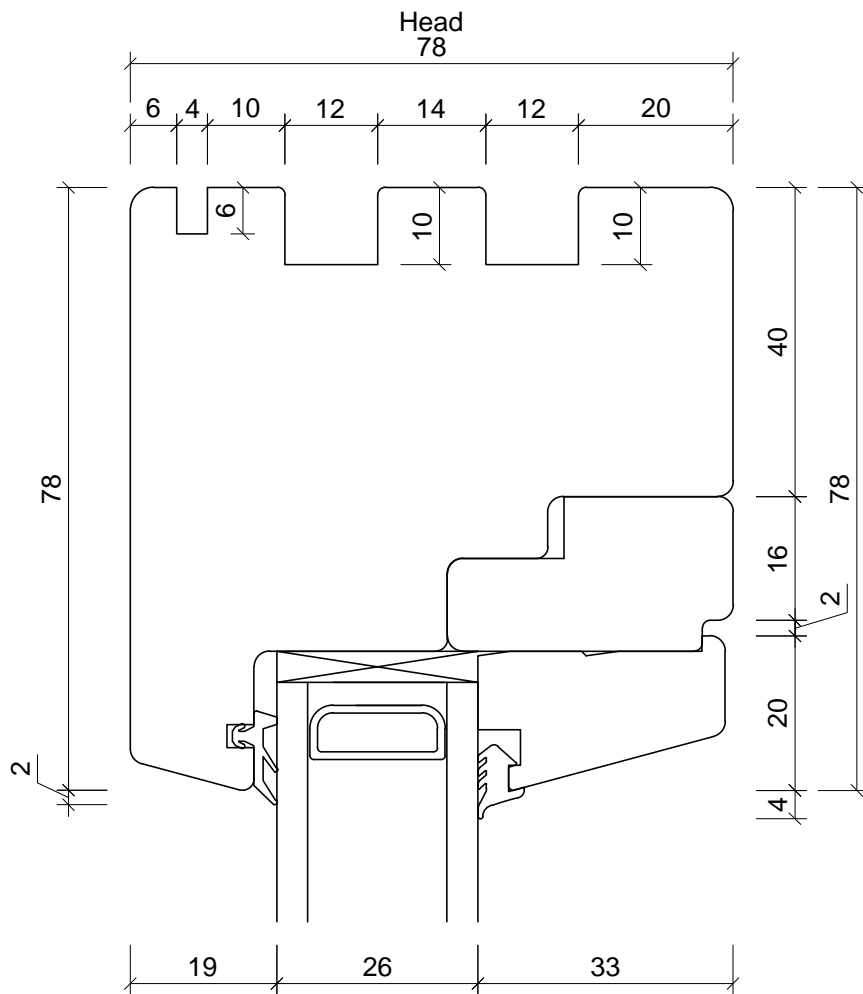
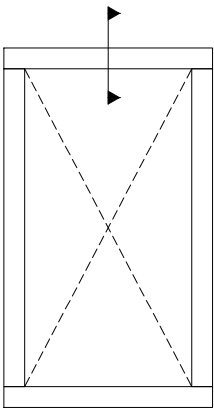

Unit 6  
Ticehurst Yard  
Tostock  
Bury St Edmunds  
Suffolk  
IP30 9PH

Tel: 01359 272 646  
sales@livingwoodwindows.co.uk  
www.livingwoodwindows.co.uk

Unit Type:

LW10  
Double Glazed Timber  
Tilt & Turn Window

Drawing No.:  
LW10-108

Date:  
28/02/13

Drawing Title:

Section Through Head  
Fixed Light

Drawn By:  
JSE

Scale:  
NTS

This drawing remains the property of Livingwood Windows Ltd and may not be reproduced without written permission. Livingwood Windows Ltd accepts no liability arising from any party acting on information contained within this drawing. It is advised that assistance is sought from Livingwood Windows Ltd regarding matters of an individual project.



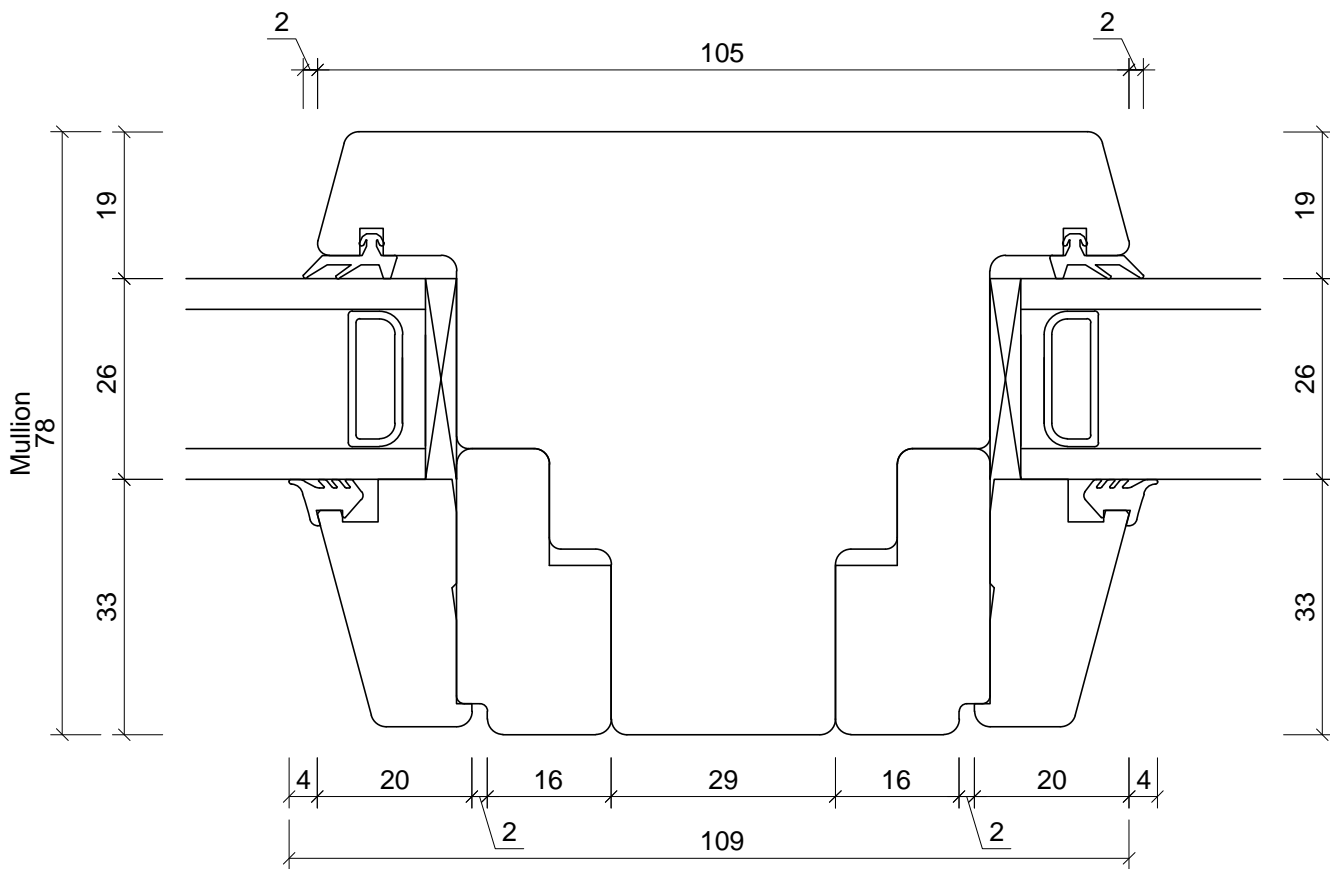
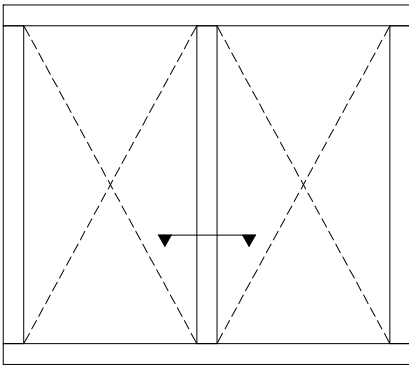

Unit 6  
 Ticehurst Yard  
 Tostock  
 Bury St Edmunds  
 Suffolk  
 IP30 9PH  
 Tel: 01359 272 646  
 sales@livingwoodwindows.co.uk  
 www.livingwoodwindows.co.uk

Unit Type:	LW10 Double Glazed Timber Tilt & Turn Window	Drawing No.: LW10-109
		Date: 28/02/13
Drawing Title:	Section Through Mullion Fixed Light/Fixed Light	Drawn By: JSE
		Scale: NTS

This drawing remains the property of Livingwood Windows Ltd and may not be reproduced without written permission.  
 Livingwood Windows Ltd accepts no liability arising from any party acting on information contained within this drawing.  
 It is advised that assistance is sought from Livingwood Windows Ltd regarding matters of an individual project.

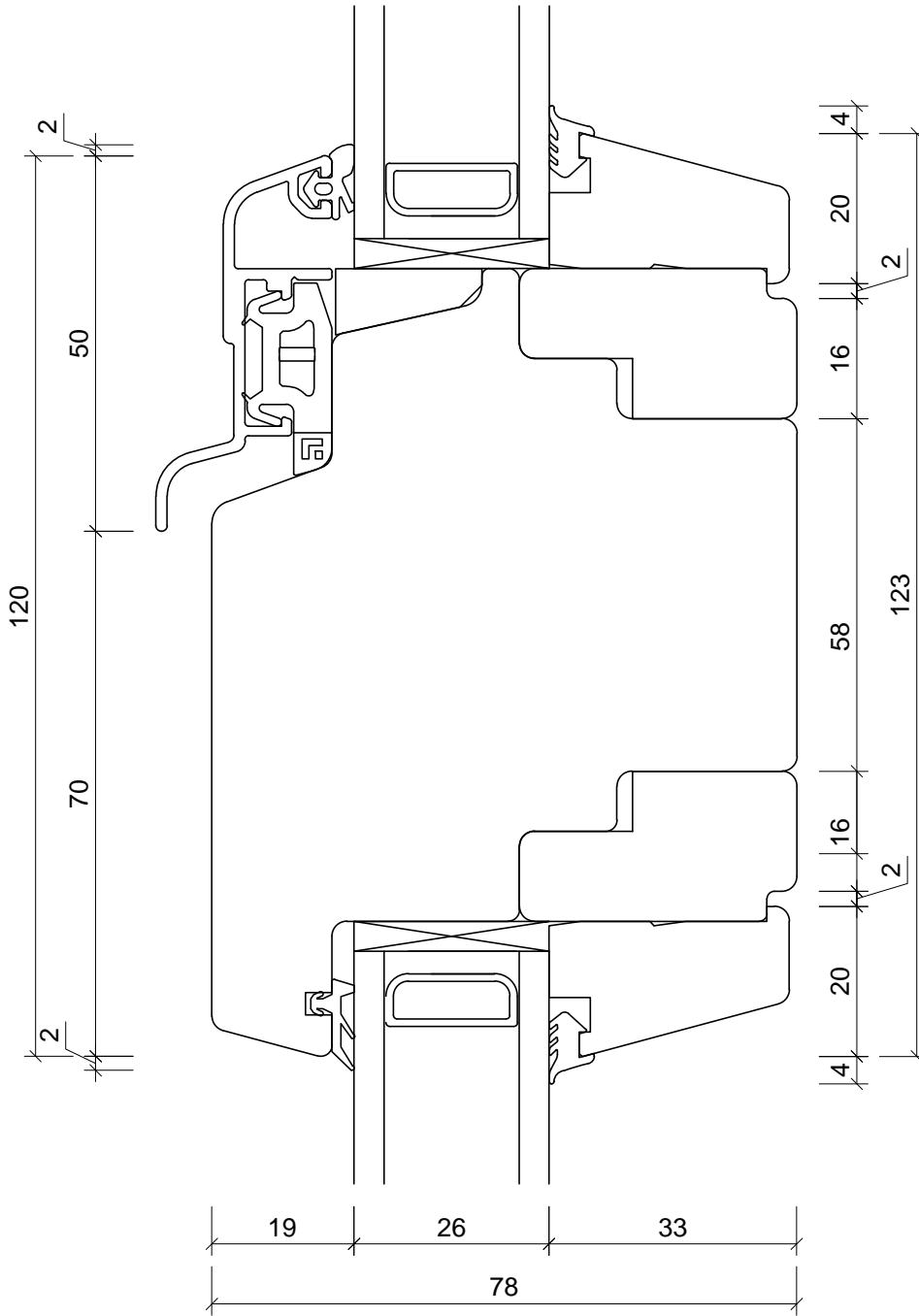
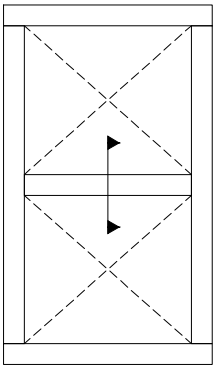

Unit 6  
Ticehurst Yard  
Tostock  
Bury St Edmunds  
Suffolk  
IP30 9PH

Tel: 01359 272 646  
sales@livingwoodwindows.co.uk  
www.livingwoodwindows.co.uk

Unit Type:

LW10  
Double Glazed Timber  
Tilt & Turn Window

Drawing Title:

Section Through Transom  
Fixed Light/Fixed Light

Drawing No.:  
LW10-110

Date:  
28/02/13

Drawn By:  
JSE

Scale:  
NTS

This drawing remains the property of Livingwood Windows Ltd and may not be reproduced without written permission. Livingwood Windows Ltd accepts no liability arising from any party acting on information contained within this drawing. It is advised that assistance is sought from Livingwood Windows Ltd regarding matters of an individual project.

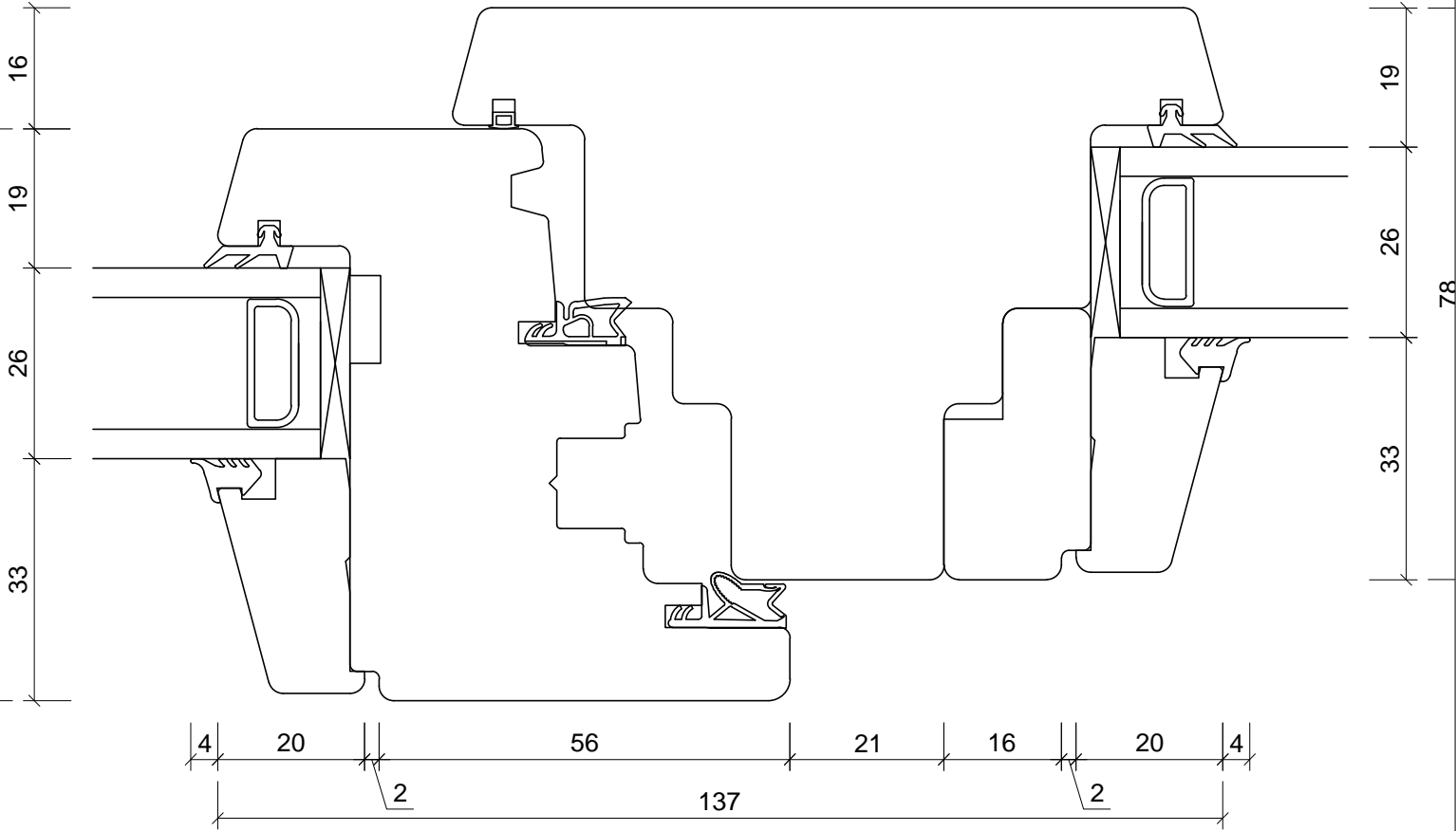
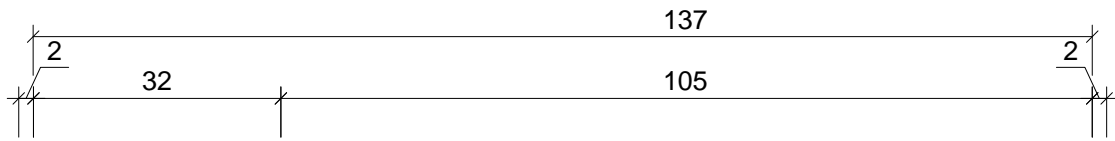
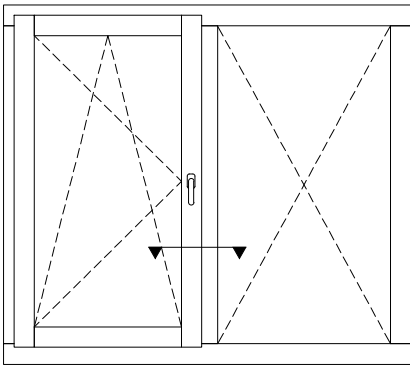

Unit 6  
Ticehurst Yard  
Tostock  
Bury St Edmunds  
Suffolk  
IP30 9PH

Tel: 01359 272 646  
sales@livingwoodwindows.co.uk  
www.livingwoodwindows.co.uk

Unit Type:

LW10  
Double Glazed Timber  
Tilt & Turn Window

Drawing No.:  
LW10-111

Date:  
28/02/13

Drawing Title:

Section Through Mullion  
Opening Sash/Fixed Light

Drawn By:  
JSE

Scale:  
NTS

This drawing remains the property of Livingwood Windows Ltd and may not be reproduced without written permission. Livingwood Windows Ltd accepts no liability arising from any party acting on information contained within this drawing. It is advised that assistance is sought from Livingwood Windows Ltd regarding matters of an individual project.

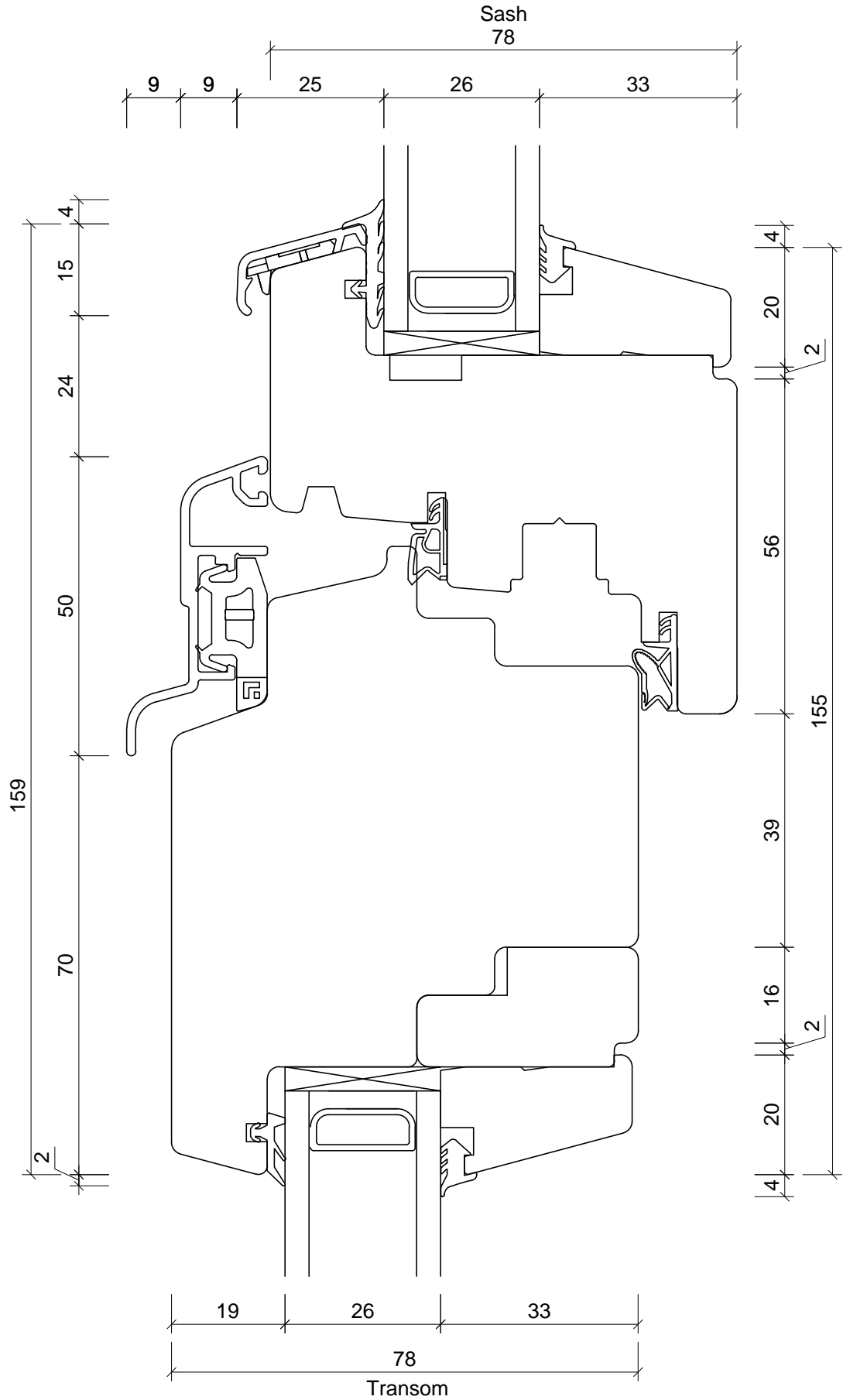
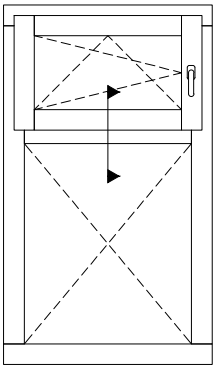

Unit 6  
Ticehurst Yard  
Tostock  
Bury St Edmunds  
Suffolk  
IP30 9PH

Tel: 01359 272 646  
sales@livingwoodwindows.co.uk  
www.livingwoodwindows.co.uk

Unit Type:

LW10  
Double Glazed Timber  
Tilt & Turn Window

Drawing Title:

Section Through Transom  
Opening Sash/Fixed Light

Drawing No.:  
LW10-112

Date:  
28/02/13

Drawn By:  
JSE

Scale:  
NTS

This drawing remains the property of Livingwood Windows Ltd and may not be reproduced without written permission. Livingwood Windows Ltd accepts no liability arising from any party acting on information contained within this drawing. It is advised that assistance is sought from Livingwood Windows Ltd regarding matters of an individual project.

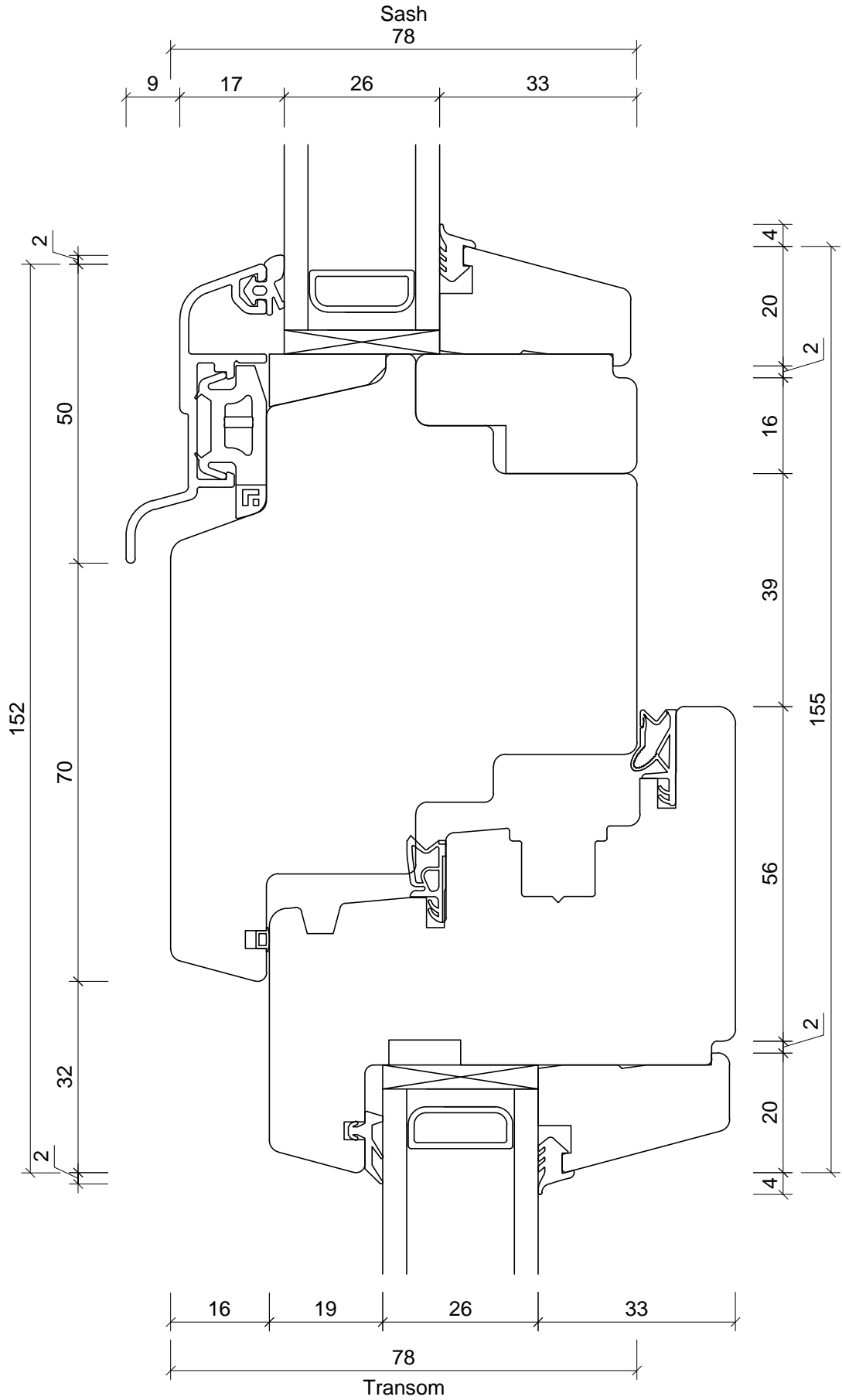
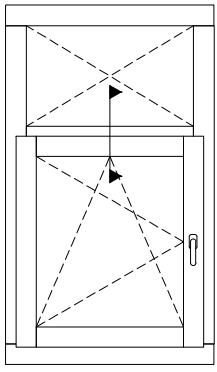

Unit 6  
Ticehurst Yard  
Tostock  
Bury St Edmunds  
Suffolk  
IP30 9PH

Tel: 01359 272 646  
sales@livingwoodwindows.co.uk  
www.livingwoodwindows.co.uk

Unit Type:

LW10  
Double Glazed Timber  
Tilt & Turn Window

Drawing No.:  
LW10-113

Date:  
28/02/13

Drawing Title:

Section Through Transom  
Fixed Light/Opening Sash

Drawn By:  
JSE

Scale:  
NTS

This drawing remains the property of Livingwood Windows Ltd and may not be reproduced without written permission. Livingwood Windows Ltd accepts no liability arising from any party acting on information contained within this drawing. It is advised that assistance is sought from Livingwood Windows Ltd regarding matters of an individual project.

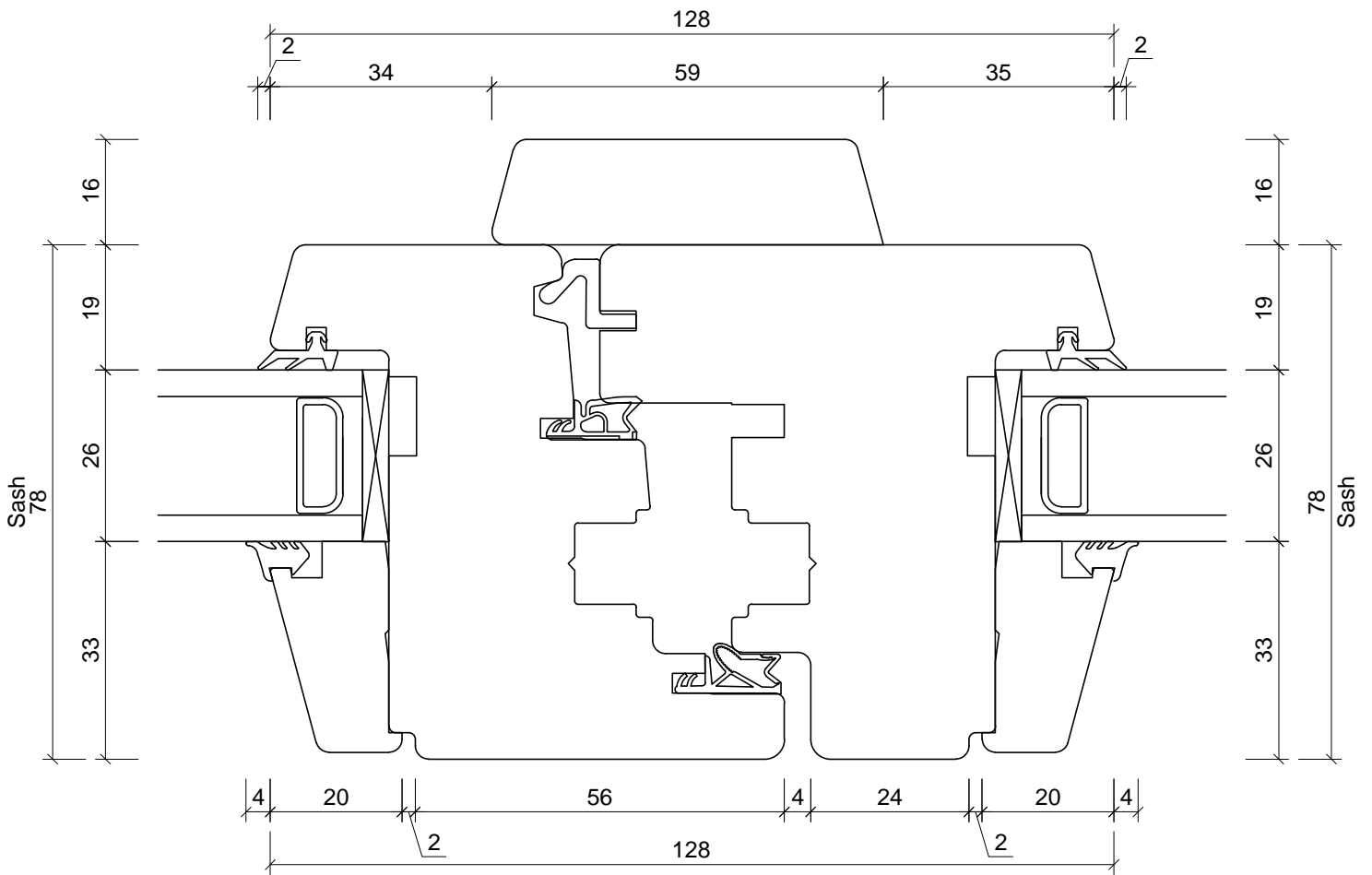
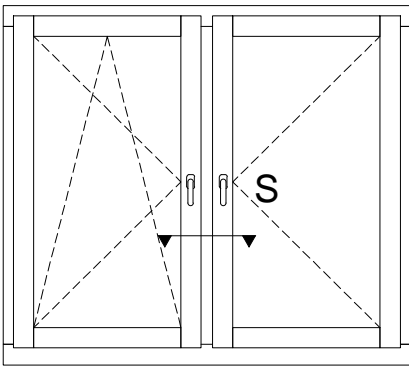

Unit 6  
Ticehurst Yard  
Tostock  
Bury St Edmunds  
Suffolk  
IP30 9PH

Tel: 01359 272 646  
sales@livingwoodwindows.co.uk  
www.livingwoodwindows.co.uk

Unit Type:  
LW10  
Double Glazed Timber  
Tilt & Turn Window

Drawing Title:  
Section Through Flying Mullion  
Primary Sash/Secondary Sash

Drawing No.:  
LW10-114

Date:  
28/02/13

Drawn By:  
JSE

Scale:  
NTS

This drawing remains the property of Livingwood Windows Ltd and may not be reproduced without written permission. Livingwood Windows Ltd accepts no liability arising from any party acting on information contained within this drawing. It is advised that assistance is sought from Livingwood Windows Ltd regarding matters of an individual project.

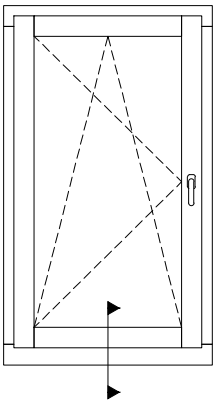

Available Sill Sizes - X

- 50mm (projects 40mm)
- 70mm (projects 60mm)
- 90mm (projects 80mm)
- 110mm (projects 100mm)
- 130mm (projects 120mm)
- 150mm (projects 140mm)
- 165mm (projects 155mm)
- 180mm (projects 170mm)
- 195mm (projects 185mm)
- 210mm (projects 200mm)
- 225mm (projects 215mm)
- 240mm (projects 230mm)
- 260mm (projects 250mm)
- 280mm (projects 270mm)
- 320mm (projects 310mm)
- 360mm (projects 350mm)

130mm - 360mm sills  
require longer lead time

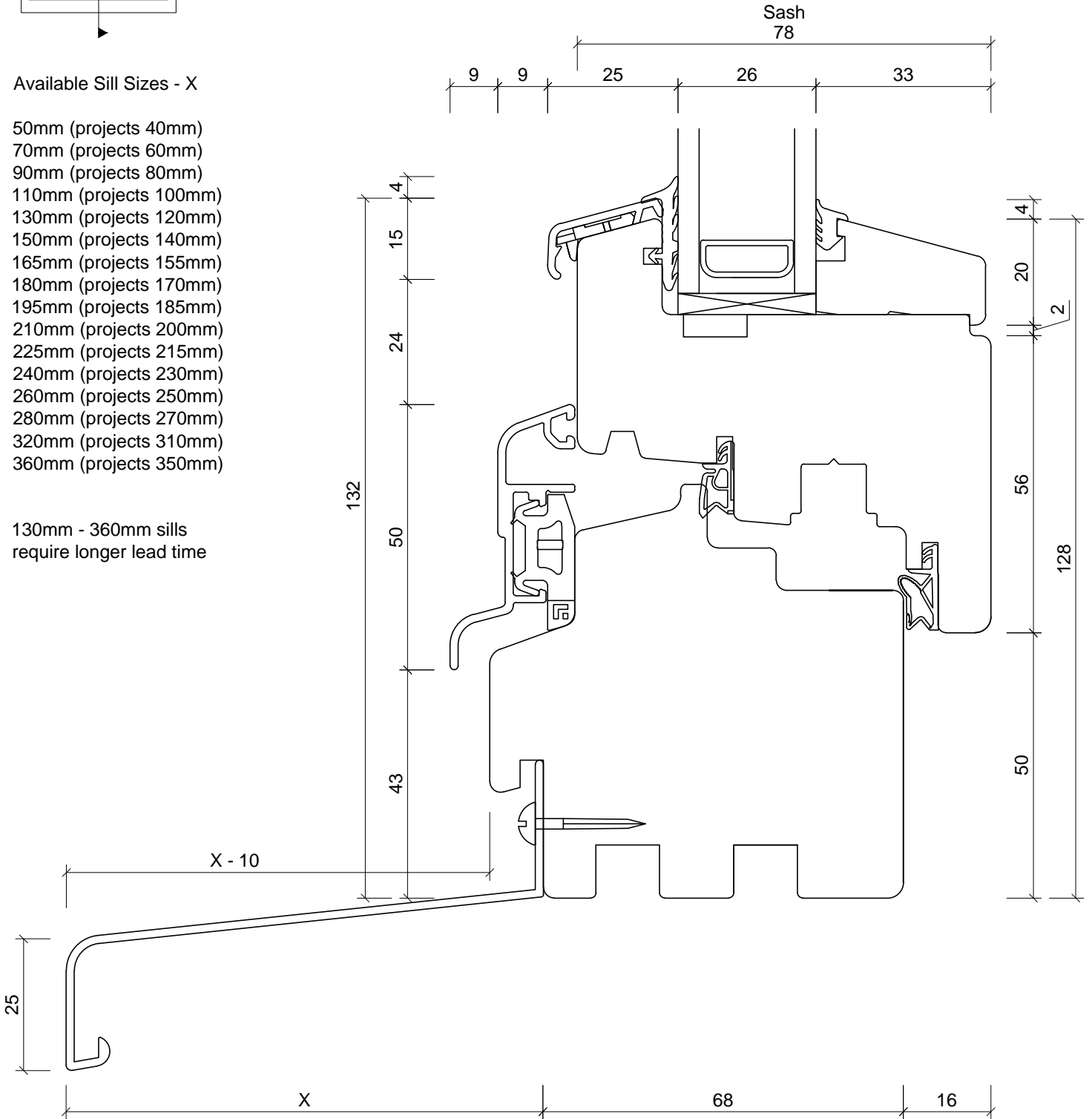

Unit 6  
Ticehurst Yard  
Tostock  
Bury St Edmunds  
Suffolk  
IP30 9PH  
  
Tel: 01359 272 646  
sales@livingwoodwindows.co.uk  
www.livingwoodwindows.co.uk

Unit Type: <b>LW10 Double Glazed Timber Tilt &amp; Turn Window</b>	Drawing No.: <b>LW10-209</b>
	Date: <b>28/02/13</b>
Drawing Title: <b>Section Through Sill Optional Aluminium Sill Extension</b>	Drawn By: <b>JSE</b>
	Scale: <b>NTS</b>

This drawing remains the property of Livingwood Windows Ltd and may not be reproduced without written permission. Livingwood Windows Ltd accepts no liability arising from any party acting on information contained within this drawing. It is advised that assistance is sought from Livingwood Windows Ltd regarding matters of an individual project.