

Unit 6  
Ticehurst Yard  
Tostock  
Bury St Edmunds  
Suffolk  
IP30 9PH

Tel: 01359 272 646  
sales@livingwoodwindows.co.uk  
www.livingwoodwindows.co.uk

Unit Type:

LW88  
Triple Glazed Timber  
Tilt & Turn Window

Drawing Title:

Section Through Sill  
Opening Sash

Drawing No.:  
LW88-101

Date:  
28/02/13

Drawn By:  
JSE

Scale:  
NTS

This drawing remains the property of Livingwood Windows Ltd and may not be reproduced without written permission. Livingwood Windows Ltd accepts no liability arising from any party acting on information contained within this drawing. It is advised that assistance is sought from Livingwood Windows Ltd regarding matters of an individual project.

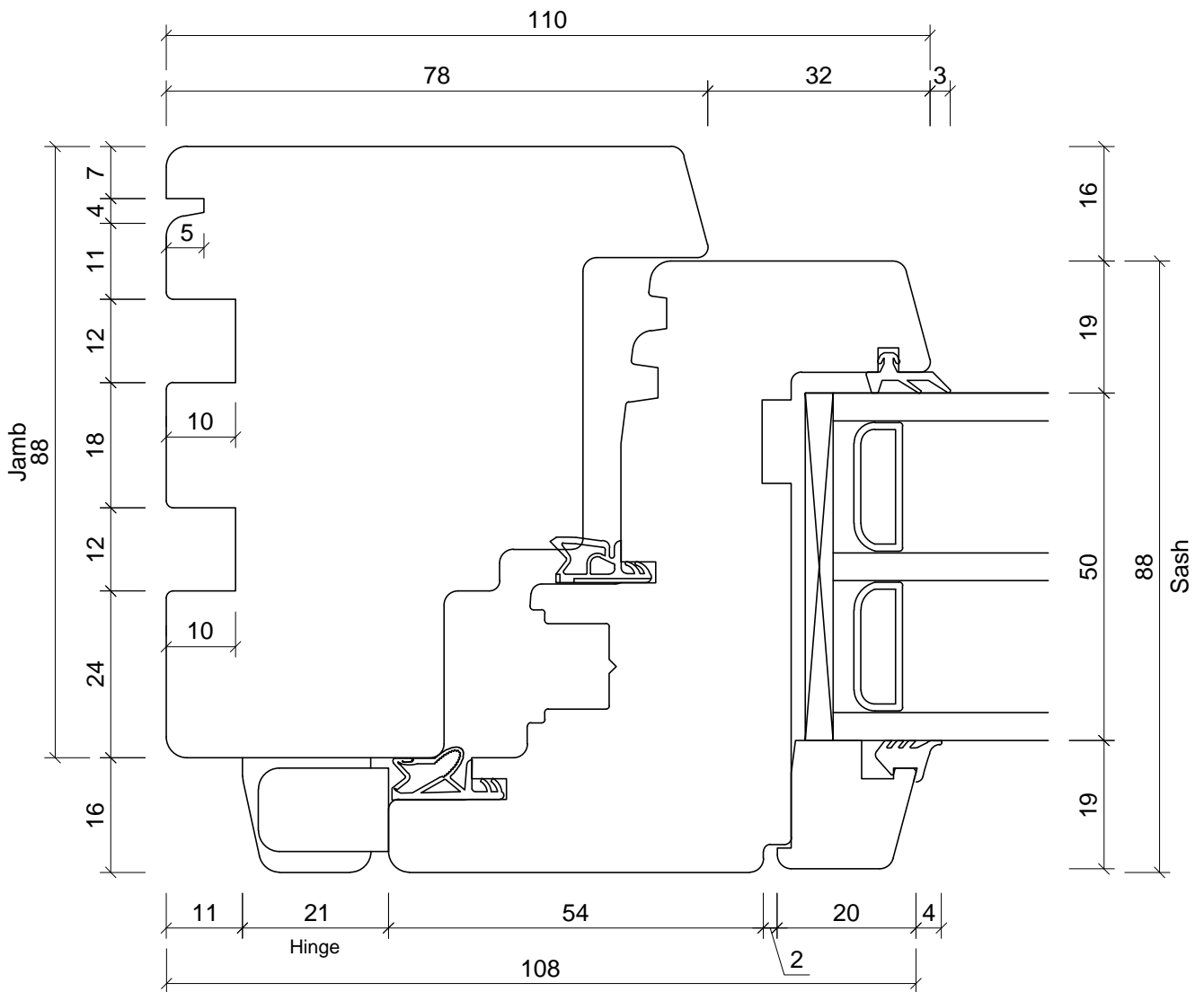
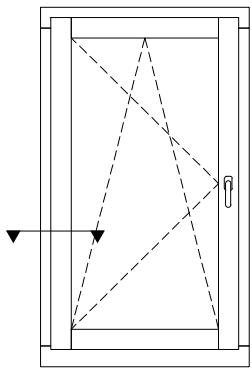

Unit 6  
Ticehurst Yard  
Tostock  
Bury St Edmunds  
Suffolk  
IP30 9PH

Tel: 01359 272 646  
sales@livingwoodwindows.co.uk  
www.livingwoodwindows.co.uk

Unit Type:

LW88  
Triple Glazed Timber  
Tilt & Turn Window

Drawing No.:  
LW88-102

Date:  
28/02/13

Drawing Title:

Section Through Jamb  
Opening Sash

Drawn By:  
JSE

Scale:  
NTS

This drawing remains the property of Livingwood Windows Ltd and may not be reproduced without written permission. Livingwood Windows Ltd accepts no liability arising from any party acting on information contained within this drawing. It is advised that assistance is sought from Livingwood Windows Ltd regarding matters of an individual project.

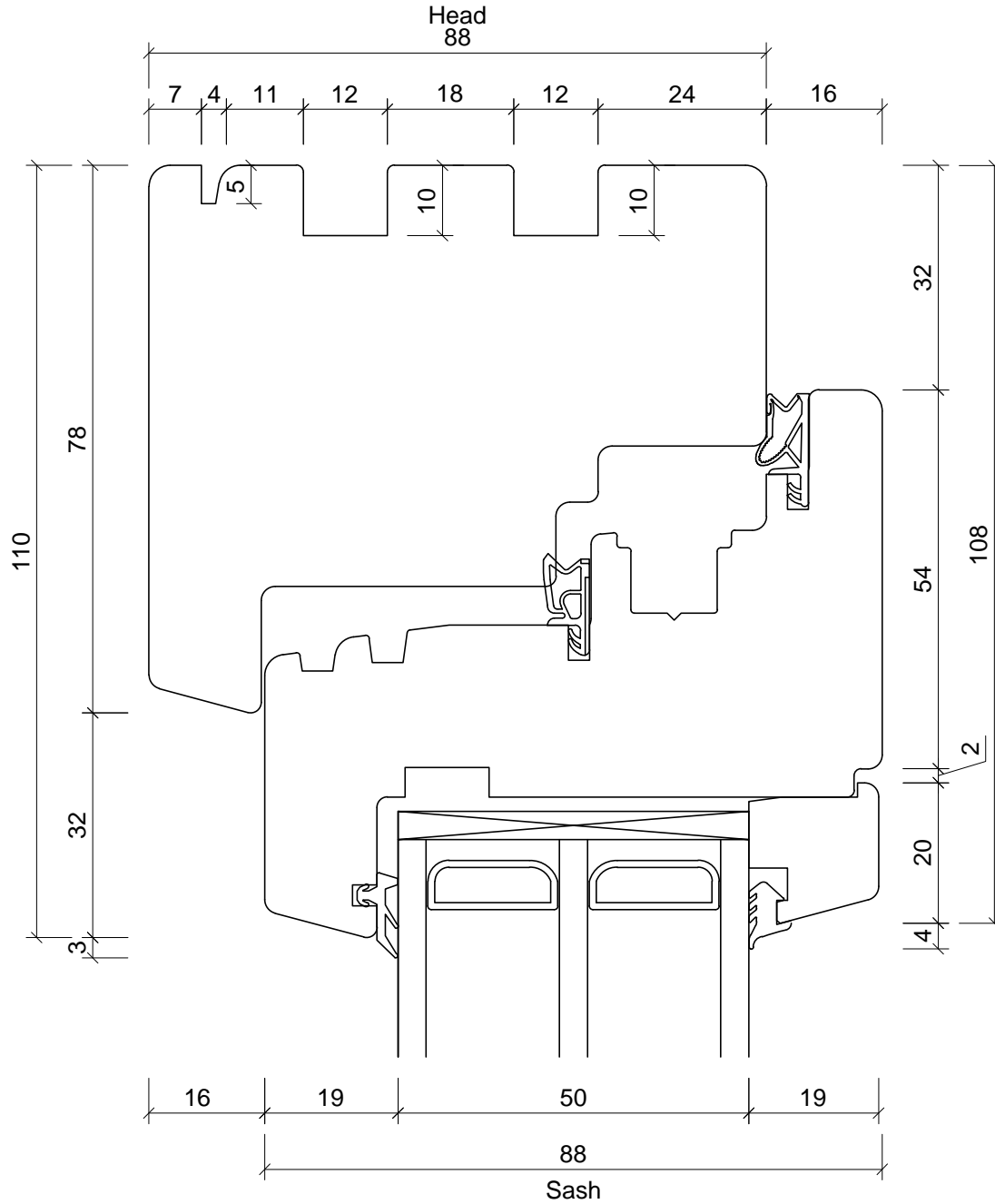
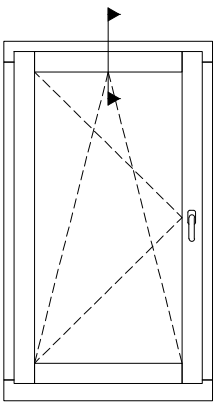

Unit 6  
Ticehurst Yard  
Tostock  
Bury St Edmunds  
Suffolk  
IP30 9PH

Tel: 01359 272 646  
sales@livingwoodwindows.co.uk  
www.livingwoodwindows.co.uk

Unit Type:

LW88  
Triple Glazed Timber  
Tilt & Turn Window

Drawing No.:  
LW88-103

Date:  
28/02/13

Drawing Title:

Section Through Head  
Opening Sash

Drawn By:  
JSE

Scale:  
NTS

This drawing remains the property of Livingwood Windows Ltd and may not be reproduced without written permission. Livingwood Windows Ltd accepts no liability arising from any party acting on information contained within this drawing. It is advised that assistance is sought from Livingwood Windows Ltd regarding matters of an individual project.

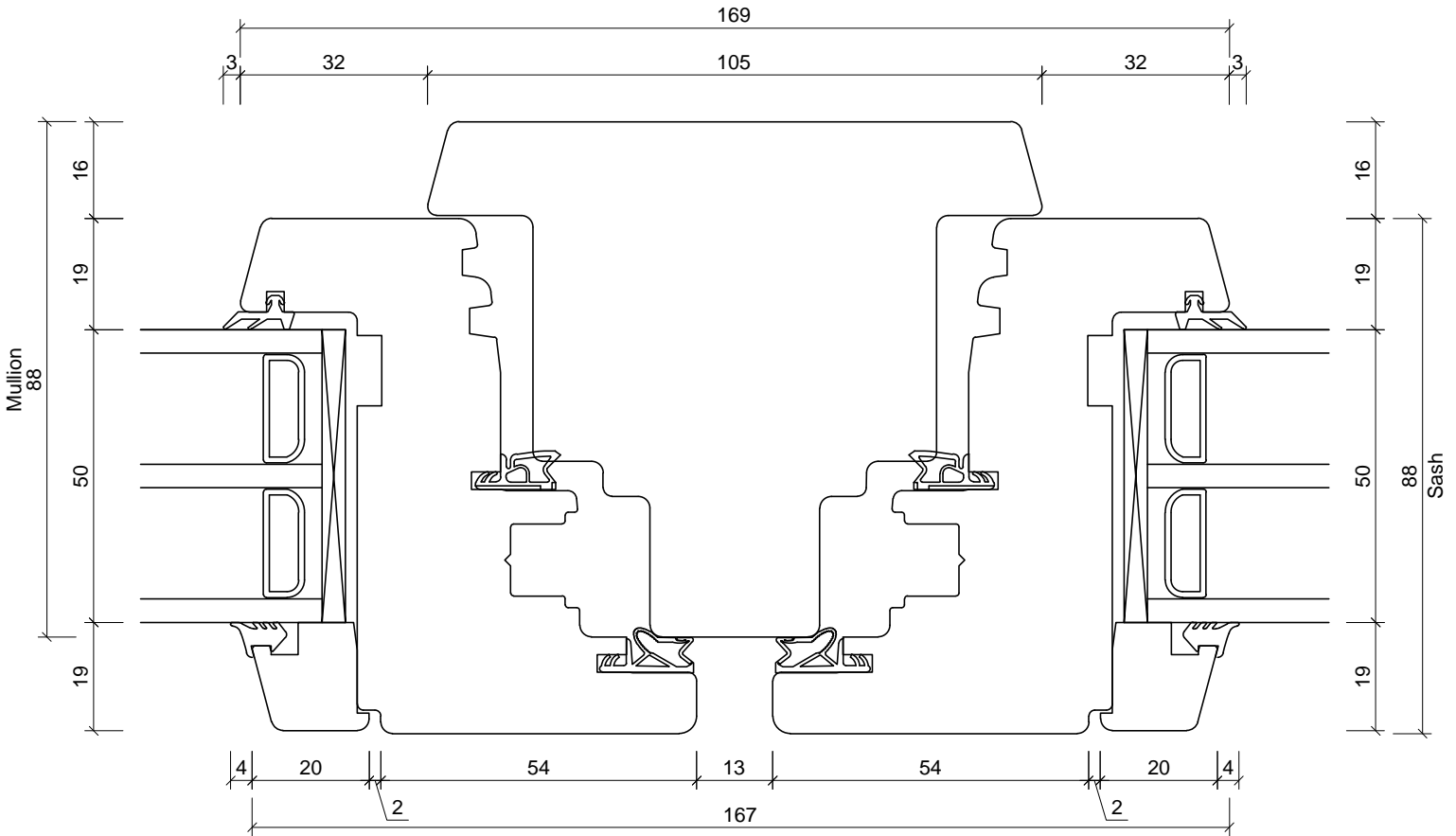
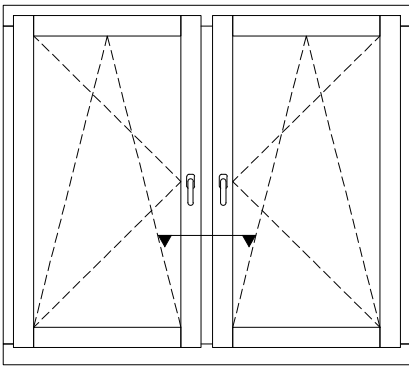

Unit 6  
Ticehurst Yard  
Tostock  
Bury St Edmunds  
Suffolk  
IP30 9PH

Tel: 01359 272 646  
sales@livingwoodwindows.co.uk  
www.livingwoodwindows.co.uk

Unit Type:	LW88 Triple Glazed Timber Tilt & Turn Window	Drawing No.: LW88-104
		Date: 28/02/13
Drawing Title:	Section Through Fixed Mullion Opening Sash/Opening Sash	Drawn By: JSE
		Scale: NTS

This drawing remains the property of Livingwood Windows Ltd and may not be reproduced without written permission. Livingwood Windows Ltd accepts no liability arising from any party acting on information contained within this drawing. It is advised that assistance is sought from Livingwood Windows Ltd regarding matters of an individual project.

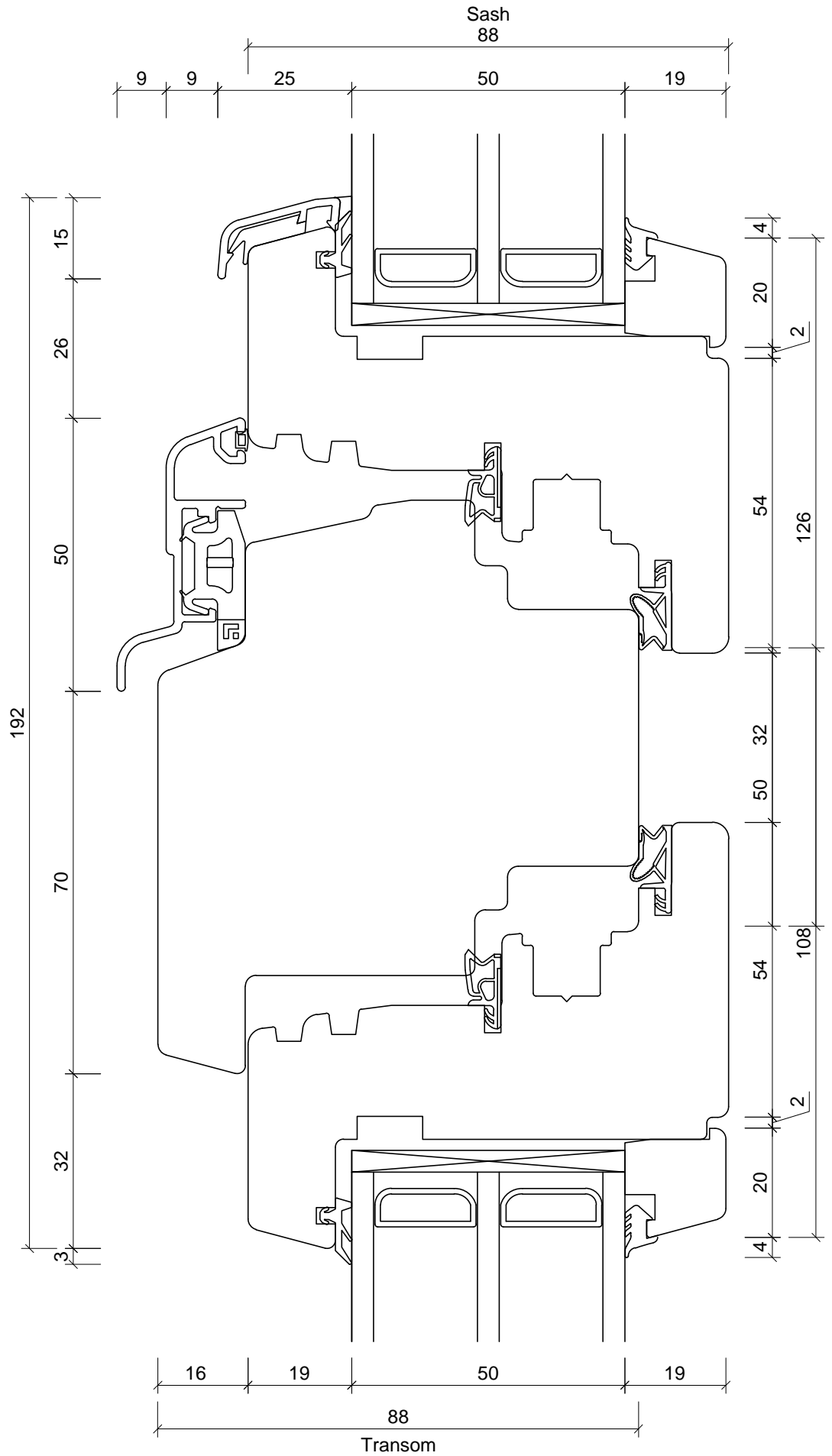
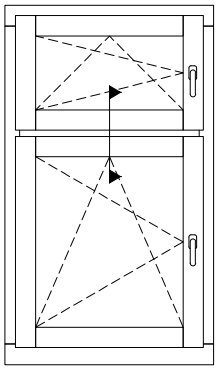

Unit 6  
Ticehurst Yard  
Tostock  
Bury St Edmunds  
Suffolk  
IP30 9PH

Tel: 01359 272 646  
sales@livingwoodwindows.co.uk  
www.livingwoodwindows.co.uk

Unit Type:	LW88 Triple Glazed Timber Tilt & Turn Window	Drawing No.: LW88-105
	Drawing Title: Section Through Transom Opening Sash/Opening Sash	Date: 28/02/13
Drawn By: JSE		
Scale: NTS		

This drawing remains the property of Livingwood Windows Ltd and may not be reproduced without written permission. Livingwood Windows Ltd accepts no liability arising from any party acting on information contained within this drawing. It is advised that assistance is sought from Livingwood Windows Ltd regarding matters of an individual project.

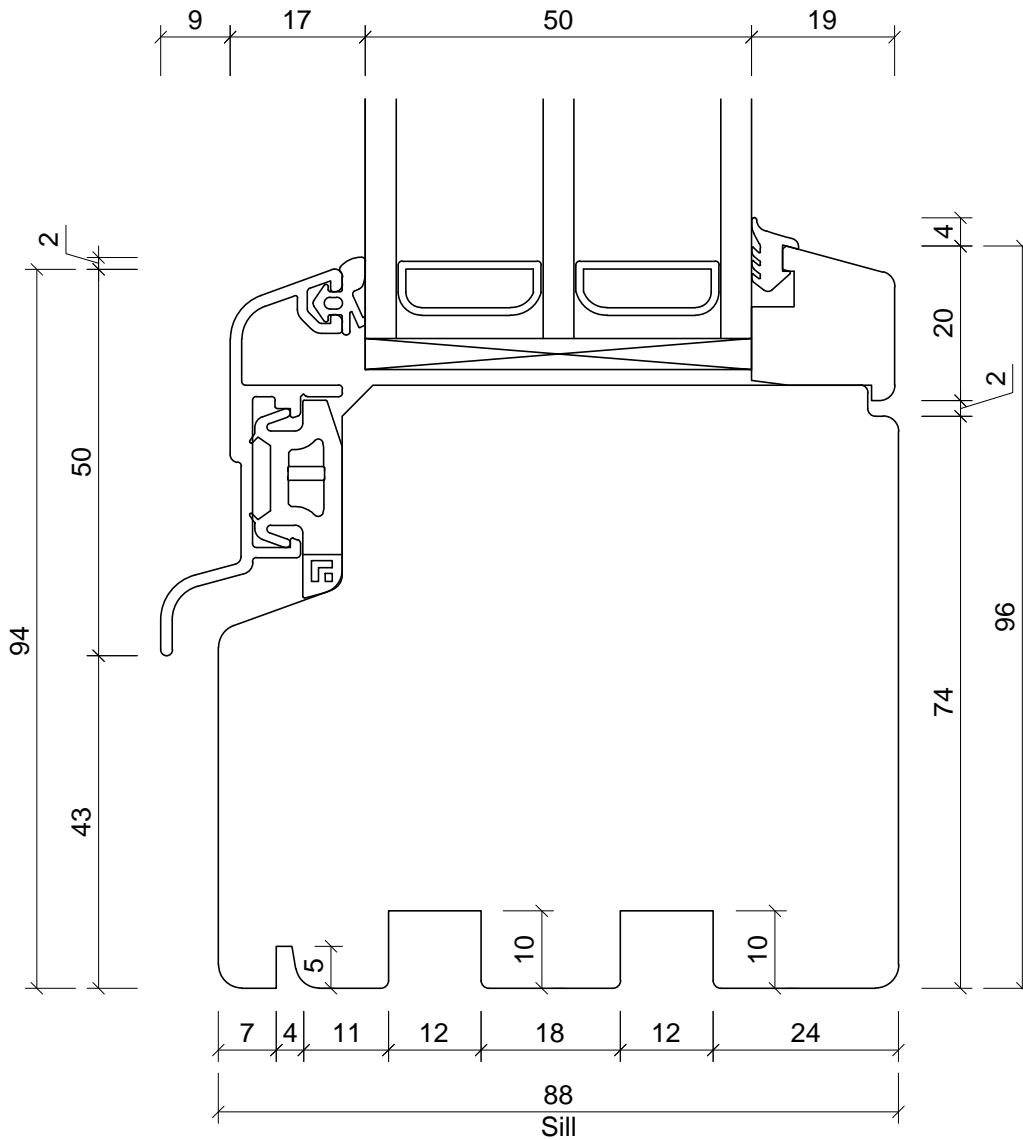
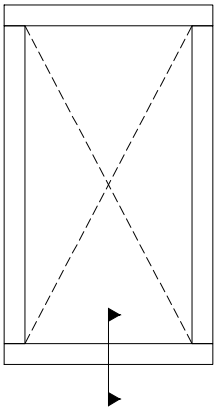

Unit 6  
Ticehurst Yard  
Tostock  
Bury St Edmunds  
Suffolk  
IP30 9PH

Tel: 01359 272 646  
sales@livingwoodwindows.co.uk  
www.livingwoodwindows.co.uk

Unit Type:

LW88  
Triple Glazed Timber  
Tilt & Turn Window

Drawing No.:  
LW88-106

Date:  
28/02/13

Drawing Title:

Section Through Sill  
Fixed Light

Drawn By:  
JSE

Scale:  
NTS

This drawing remains the property of Livingwood Windows Ltd and may not be reproduced without written permission. Livingwood Windows Ltd accepts no liability arising from any party acting on information contained within this drawing. It is advised that assistance is sought from Livingwood Windows Ltd regarding matters of an individual project.

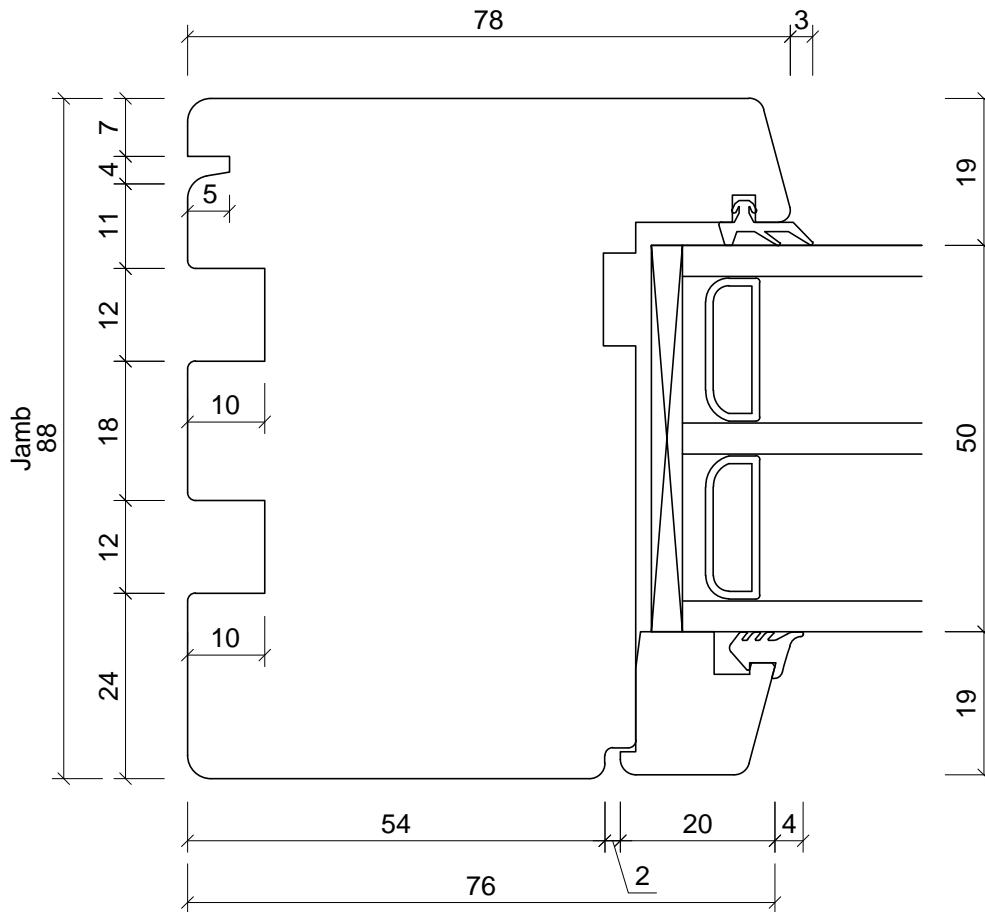
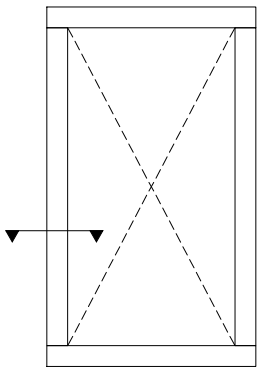

Unit 6  
Ticehurst Yard  
Tostock  
Bury St Edmunds  
Suffolk  
IP30 9PH

Tel: 01359 272 646  
sales@livingwoodwindows.co.uk  
www.livingwoodwindows.co.uk

Unit Type:	LW88 Triple Glazed Timber Tilt & Turn Window	Drawing No.: LW88-107
		Date: 28/02/13
Drawing Title:	Section Through Jamb Fixed Light	Drawn By: JSE
		Scale: NTS

This drawing remains the property of Livingwood Windows Ltd and may not be reproduced without written permission. Livingwood Windows Ltd accepts no liability arising from any party acting on information contained within this drawing. It is advised that assistance is sought from Livingwood Windows Ltd regarding matters of an individual project.

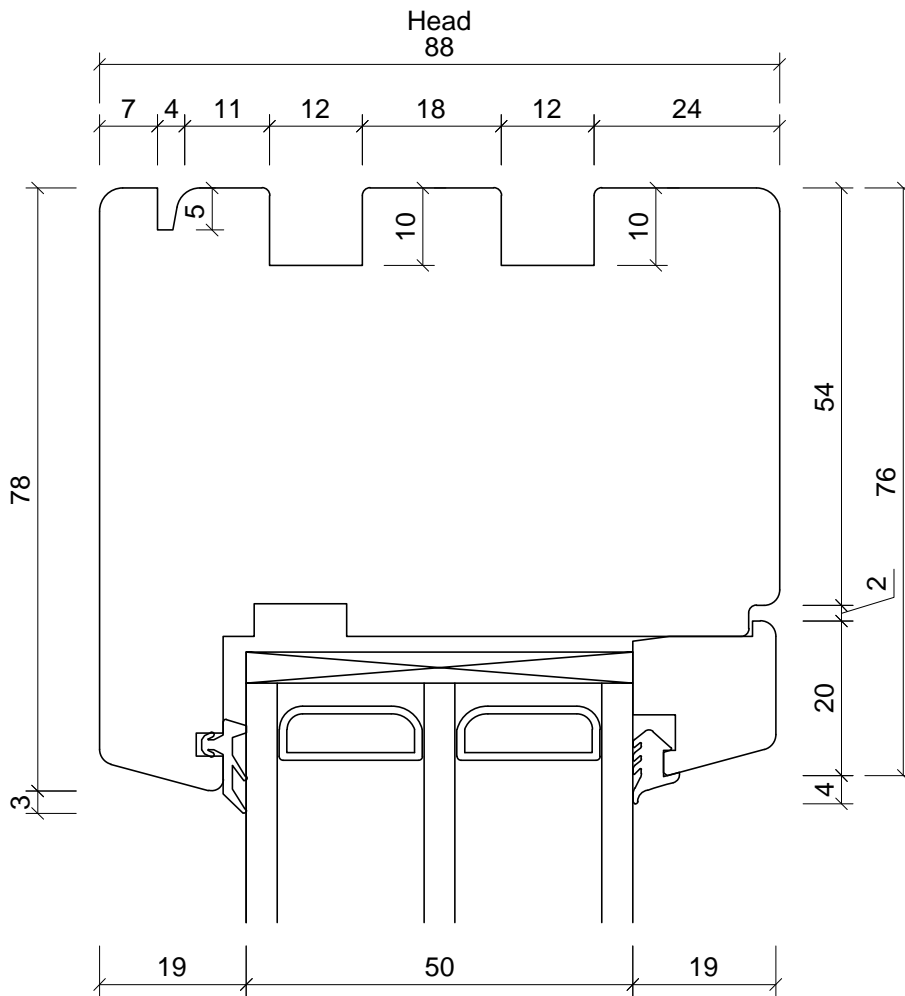
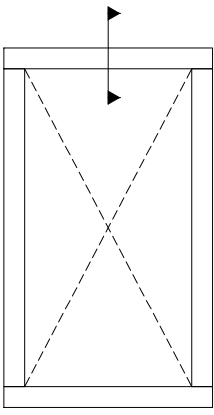

Unit 6  
Ticehurst Yard  
Tostock  
Bury St Edmunds  
Suffolk  
IP30 9PH

Tel: 01359 272 646  
sales@livingwoodwindows.co.uk  
www.livingwoodwindows.co.uk

Unit Type:

LW88  
Triple Glazed Timber  
Tilt & Turn Window

Drawing Title:

Section Through Head  
Fixed Light

Drawing No.:  
LW88-108

Date:  
28/02/13

Drawn By:  
JSE

Scale:  
NTS

This drawing remains the property of Livingwood Windows Ltd and may not be reproduced without written permission. Livingwood Windows Ltd accepts no liability arising from any party acting on information contained within this drawing. It is advised that assistance is sought from Livingwood Windows Ltd regarding matters of an individual project.



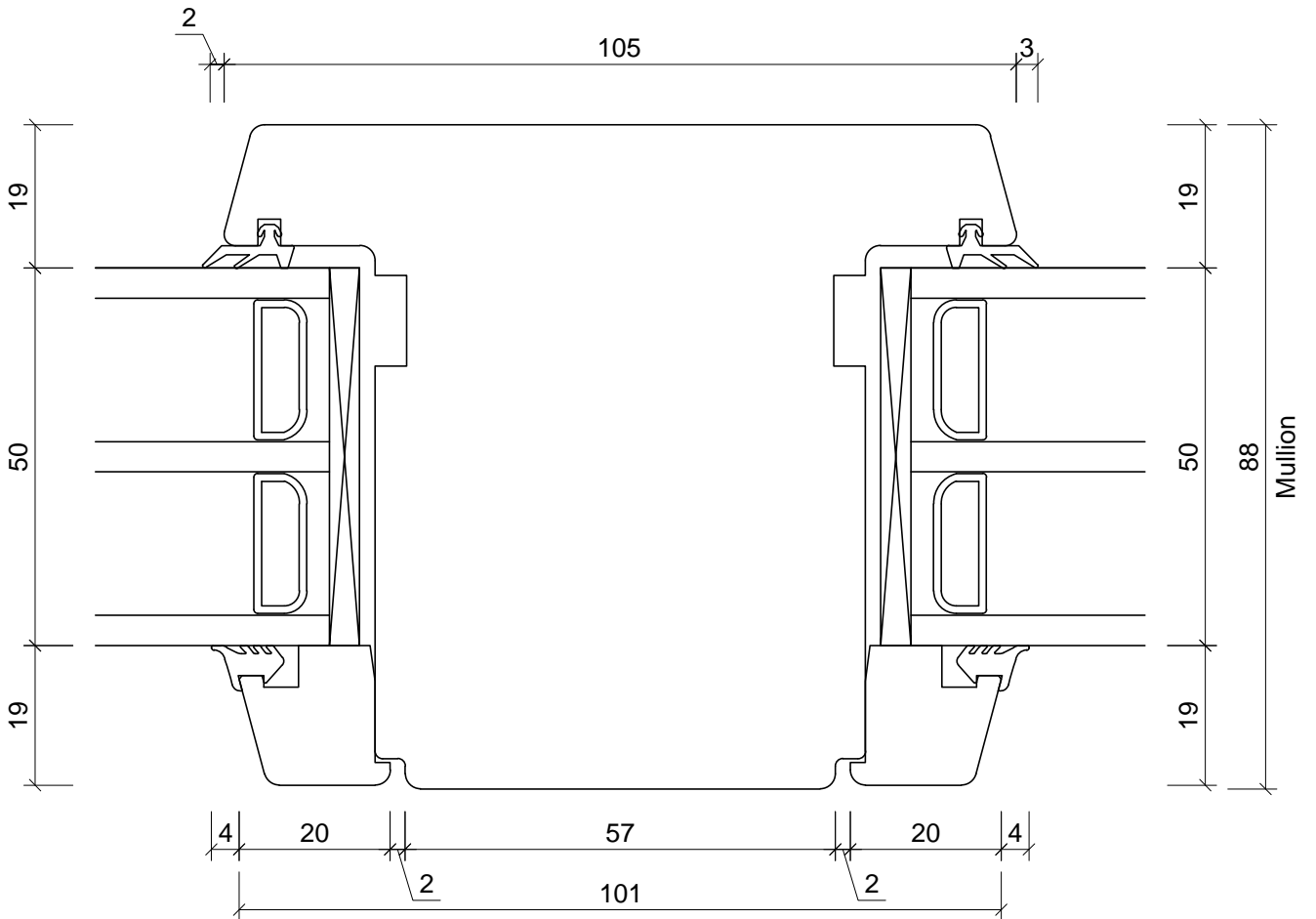
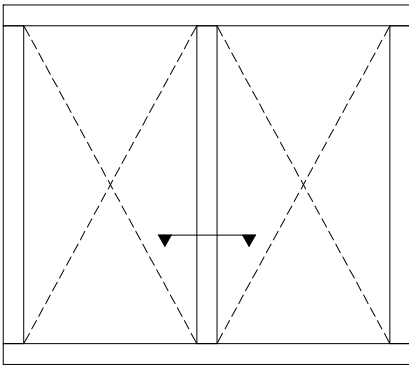

Unit 6  
Ticehurst Yard  
Tostock  
Bury St Edmunds  
Suffolk  
IP30 9PH

Tel: 01359 272 646  
sales@livingwoodwindows.co.uk  
www.livingwoodwindows.co.uk

Unit Type:

LW88  
Triple Glazed Timber  
Tilt & Turn Window

Drawing No.:  
LW88-109

Date:  
28/02/13

Drawing Title:

Section Through Mullion  
Fixed Light/Fixed Light

Drawn By:  
JSE

Scale:  
NTS

This drawing remains the property of Livingwood Windows Ltd and may not be reproduced without written permission. Livingwood Windows Ltd accepts no liability arising from any party acting on information contained within this drawing. It is advised that assistance is sought from Livingwood Windows Ltd regarding matters of an individual project.

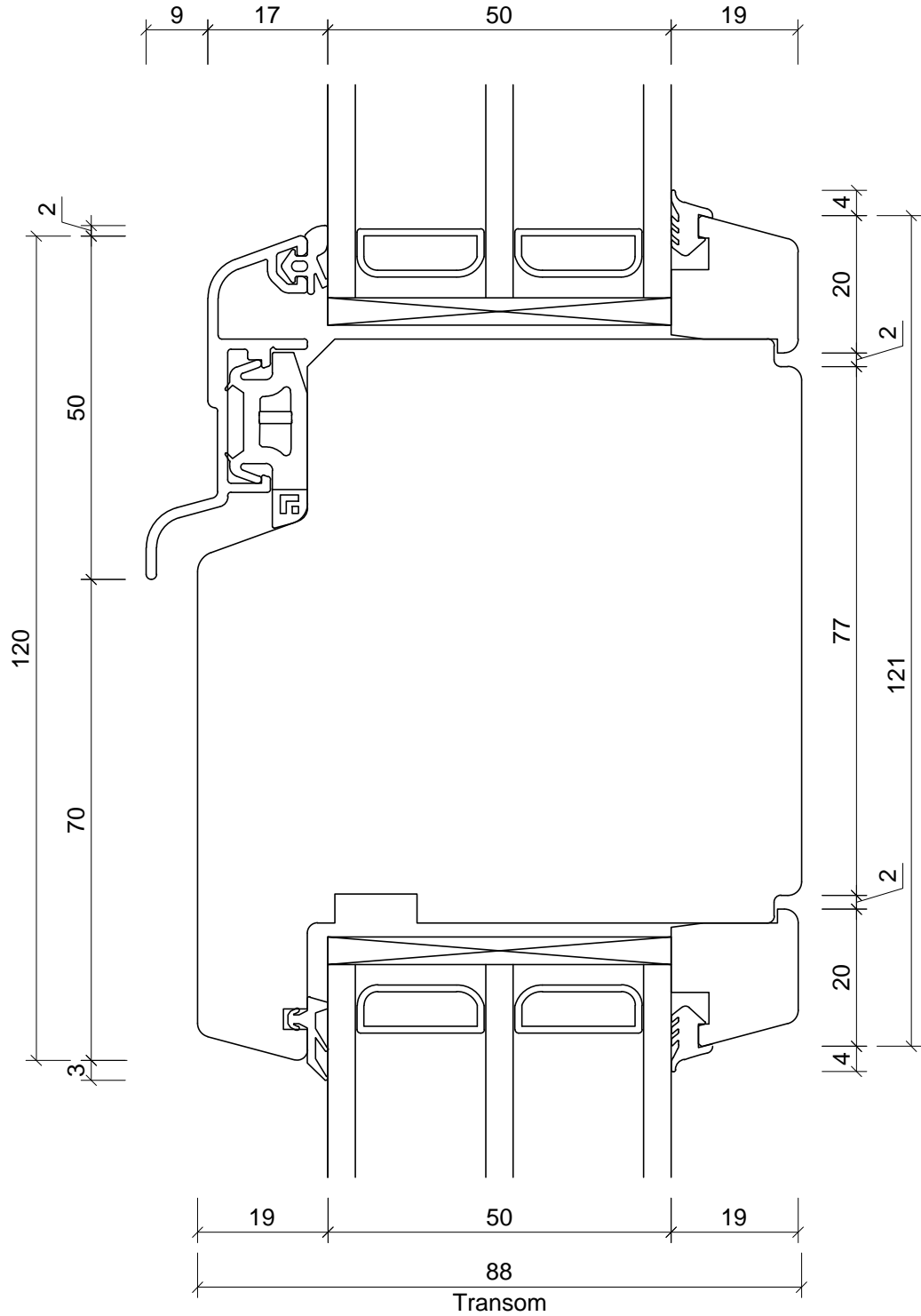
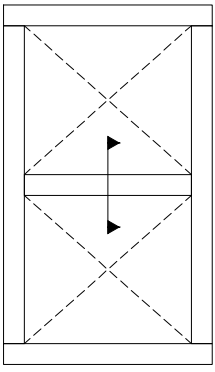

Transom



Unit 6  
Ticehurst Yard  
Tostock  
Bury St Edmunds  
Suffolk  
IP30 9PH

Tel: 01359 272 646  
sales@livingwoodwindows.co.uk  
www.livingwoodwindows.co.uk

Unit Type:

LW88  
Triple Glazed Timber  
Tilt & Turn Window

Drawing Title:

Section Through Transom  
Fixed Light/Fixed Light

Drawing No.:  
LW88-110

Date:  
28/02/13

Drawn By:  
JSE

Scale:  
NTS

This drawing remains the property of Livingwood Windows Ltd and may not be reproduced without written permission. Livingwood Windows Ltd accepts no liability arising from any party acting on information contained within this drawing. It is advised that assistance is sought from Livingwood Windows Ltd regarding matters of an individual project.

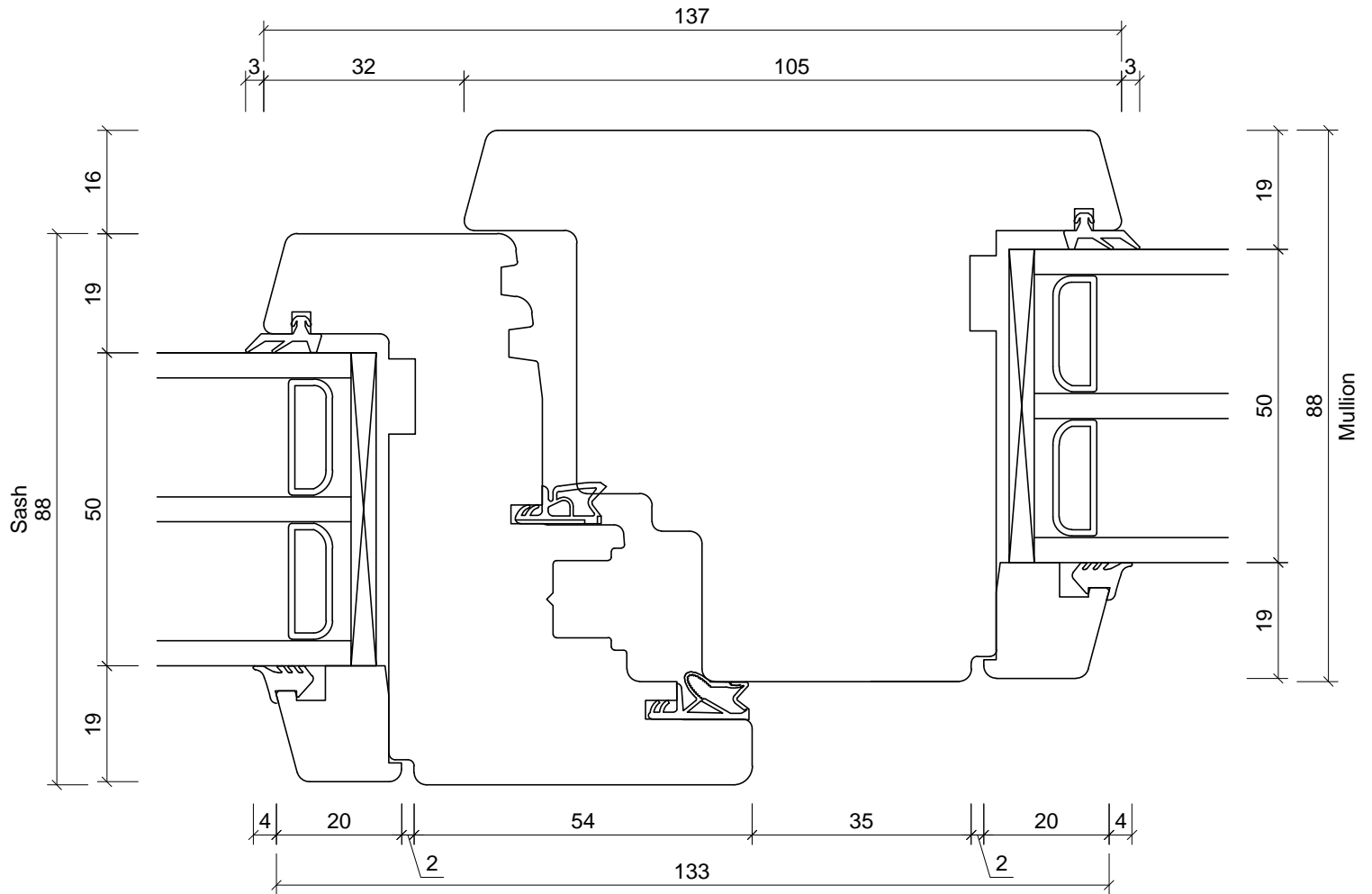
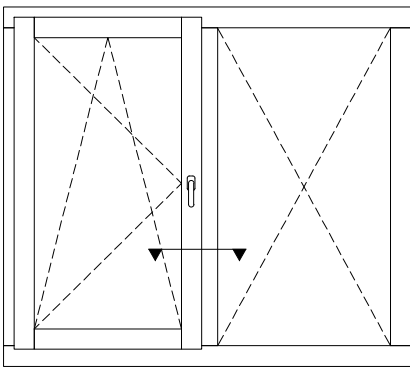

Unit 6  
 Ticehurst Yard  
 Tostock  
 Bury St Edmunds  
 Suffolk  
 IP30 9PH

Tel: 01359 272 646  
 sales@livingwoodwindows.co.uk  
 www.livingwoodwindows.co.uk

Unit Type:

LW88  
 Triple Glazed Timber  
 Tilt & Turn Window

Drawing No.:  
LW88-111

Date:  
28/02/13

Drawing Title:

Section Through Mullion  
 Opening Sash/Fixed Light

Drawn By:  
JSE

Scale:  
NTS

This drawing remains the property of Livingwood Windows Ltd and may not be reproduced without written permission.  
 Livingwood Windows Ltd accepts no liability arising from any party acting on information contained within this drawing.  
 It is advised that assistance is sought from Livingwood Windows Ltd regarding matters of an individual project.

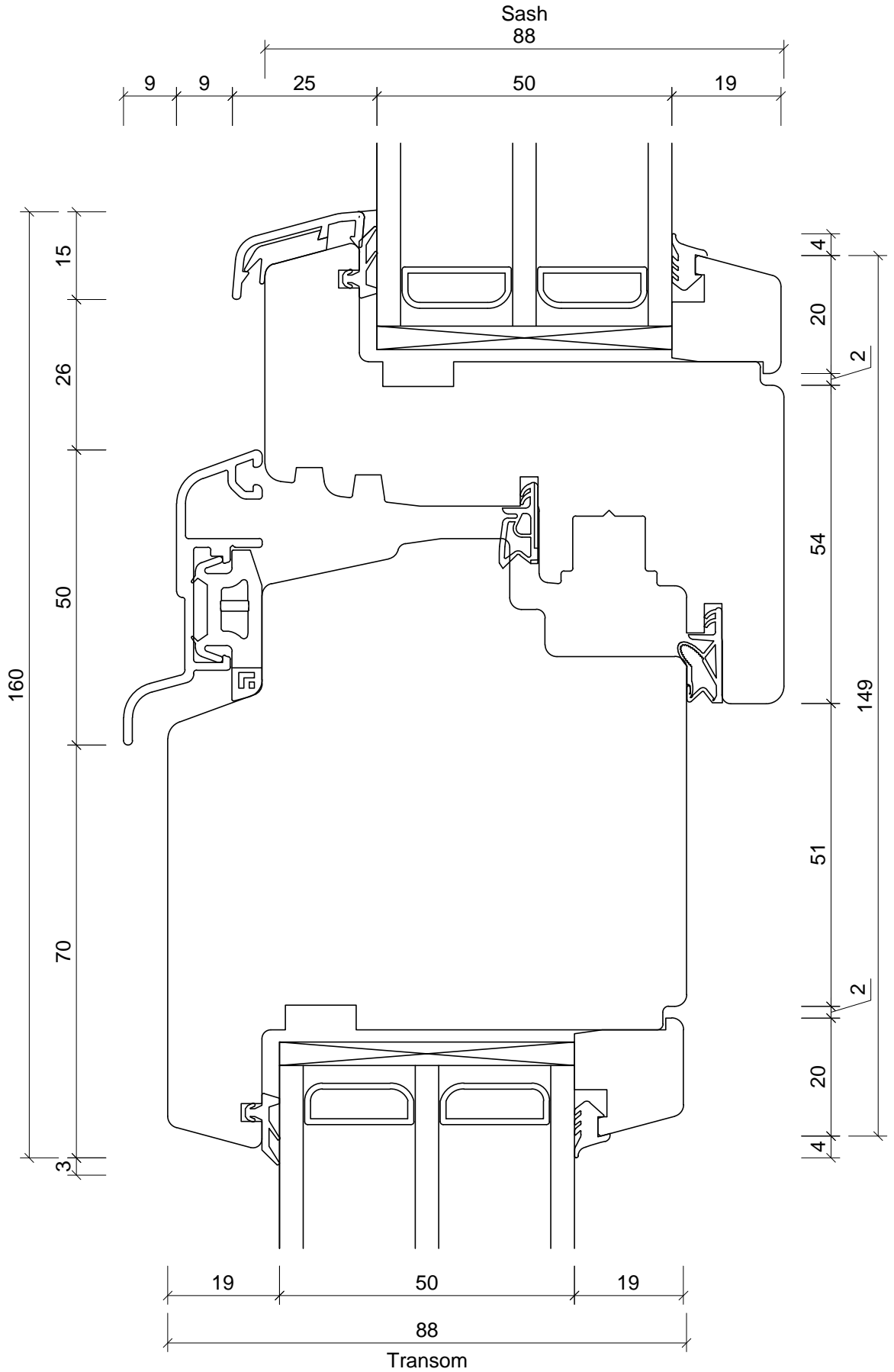
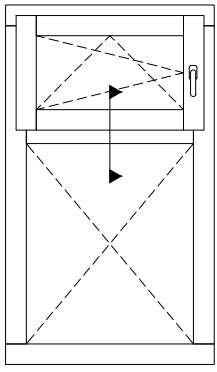

Unit 6  
Ticehurst Yard  
Tostock  
Bury St Edmunds  
Suffolk  
IP30 9PH

Tel: 01359 272 646  
sales@livingwoodwindows.co.uk  
www.livingwoodwindows.co.uk

Unit Type:

LW88  
Triple Glazed Timber  
Tilt & Turn Window

Drawing No.:  
LW88-112

Date:  
28/02/13

Drawing Title:

Section Through Transom  
Opening Sash/Fixed Light

Drawn By:  
JSE

Scale:  
NTS

This drawing remains the property of Livingwood Windows Ltd and may not be reproduced without written permission. Livingwood Windows Ltd accepts no liability arising from any party acting on information contained within this drawing. It is advised that assistance is sought from Livingwood Windows Ltd regarding matters of an individual project.

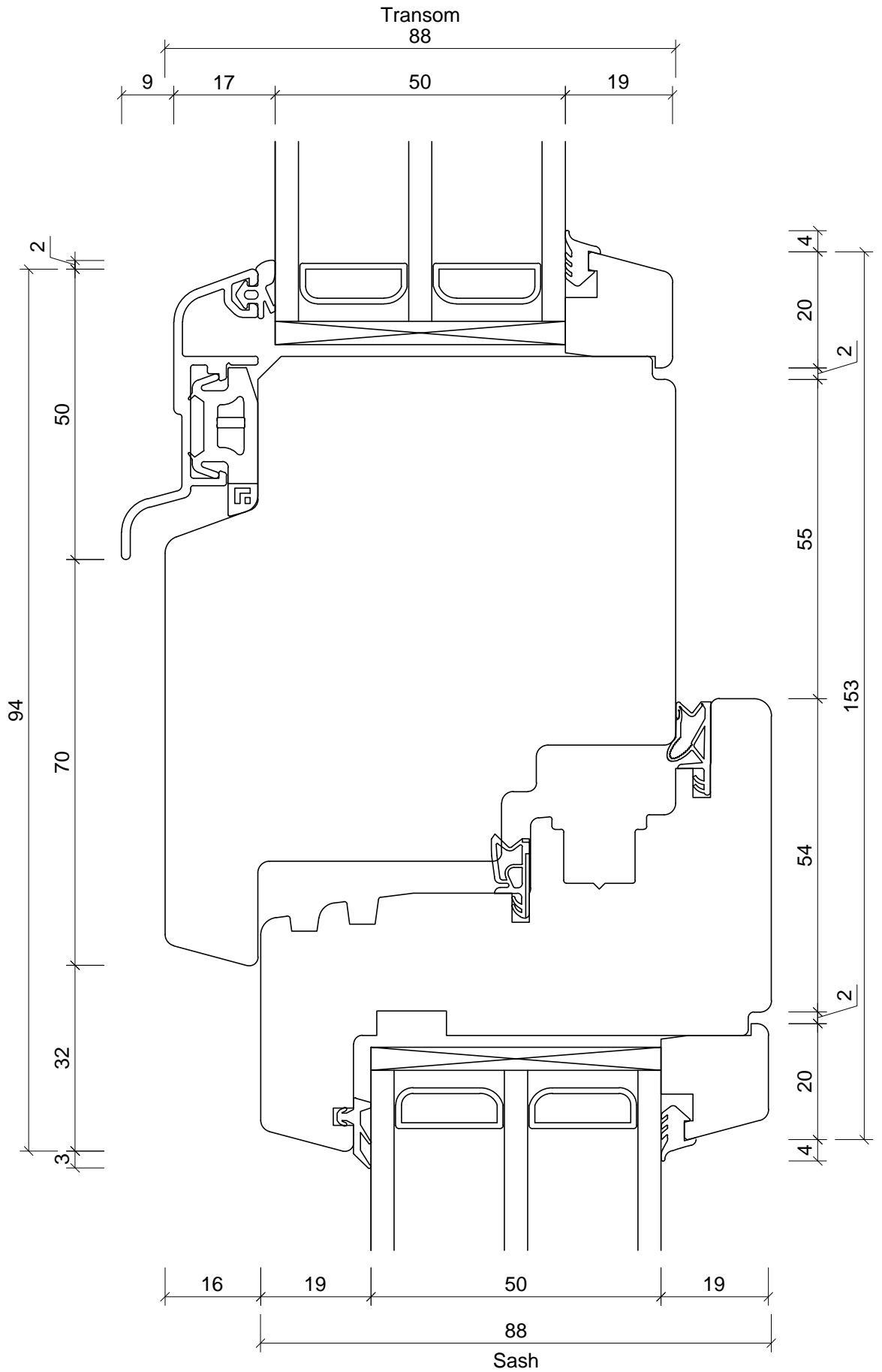
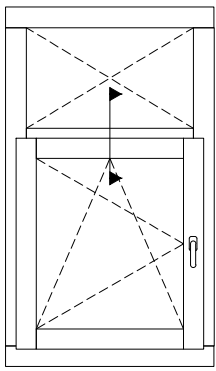

Unit 6  
Ticehurst Yard  
Tostock  
Bury St Edmunds  
Suffolk  
IP30 9PH

Tel: 01359 272 646  
sales@livingwoodwindows.co.uk  
www.livingwoodwindows.co.uk

Unit Type:

LW88  
Triple Glazed Timber  
Tilt & Turn Window

Drawing Title:

Section Through Transom  
Fixed Light/Opening Sash

Drawing No.:  
LW88-113

Date:  
28/02/13

Drawn By:  
JSE

Scale:  
NTS

This drawing remains the property of Livingwood Windows Ltd and may not be reproduced without written permission. Livingwood Windows Ltd accepts no liability arising from any party acting on information contained within this drawing. It is advised that assistance is sought from Livingwood Windows Ltd regarding matters of an individual project.

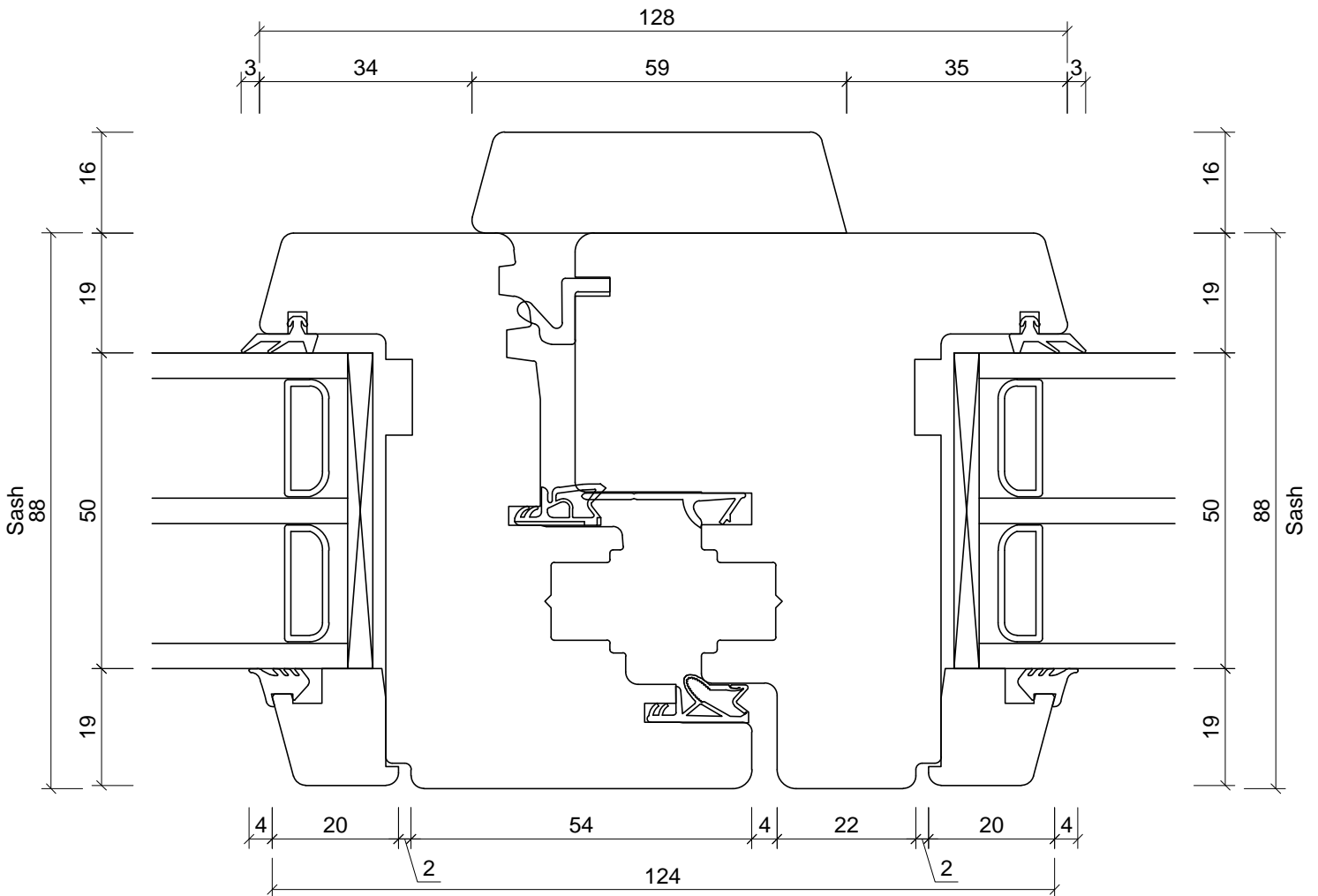
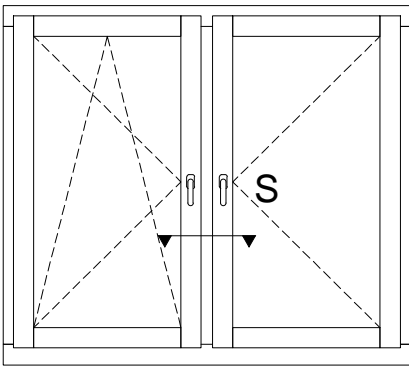

Unit 6  
Ticehurst Yard  
Tostock  
Bury St Edmunds  
Suffolk  
IP30 9PH

Tel: 01359 272 646  
sales@livingwoodwindows.co.uk  
www.livingwoodwindows.co.uk

Unit Type:

LW88  
Triple Glazed Timber  
Tilt & Turn Window

Drawing No.:  
LW88-114

Date:  
28/02/13

Drawing Title:

Section Through Flying Mullion  
Primary Sash/Secondary Sash

Drawn By:  
JSE

Scale:  
NTS

This drawing remains the property of Livingwood Windows Ltd and may not be reproduced without written permission. Livingwood Windows Ltd accepts no liability arising from any party acting on information contained within this drawing. It is advised that assistance is sought from Livingwood Windows Ltd regarding matters of an individual project.

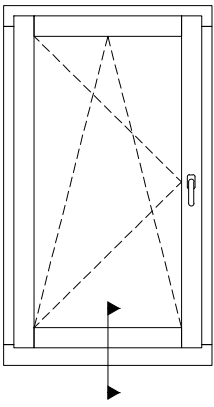

Available Sill Sizes - X

- 50mm (projects 40mm)
- 70mm (projects 60mm)
- 90mm (projects 80mm)
- 110mm (projects 100mm)
- 130mm (projects 120mm)
- 150mm (projects 140mm)
- 165mm (projects 155mm)
- 180mm (projects 170mm)
- 195mm (projects 185mm)
- 210mm (projects 200mm)
- 225mm (projects 215mm)
- 240mm (projects 230mm)
- 260mm (projects 250mm)
- 280mm (projects 270mm)
- 320mm (projects 310mm)
- 360mm (projects 350mm)

130mm - 360mm sills  
require longer lead time

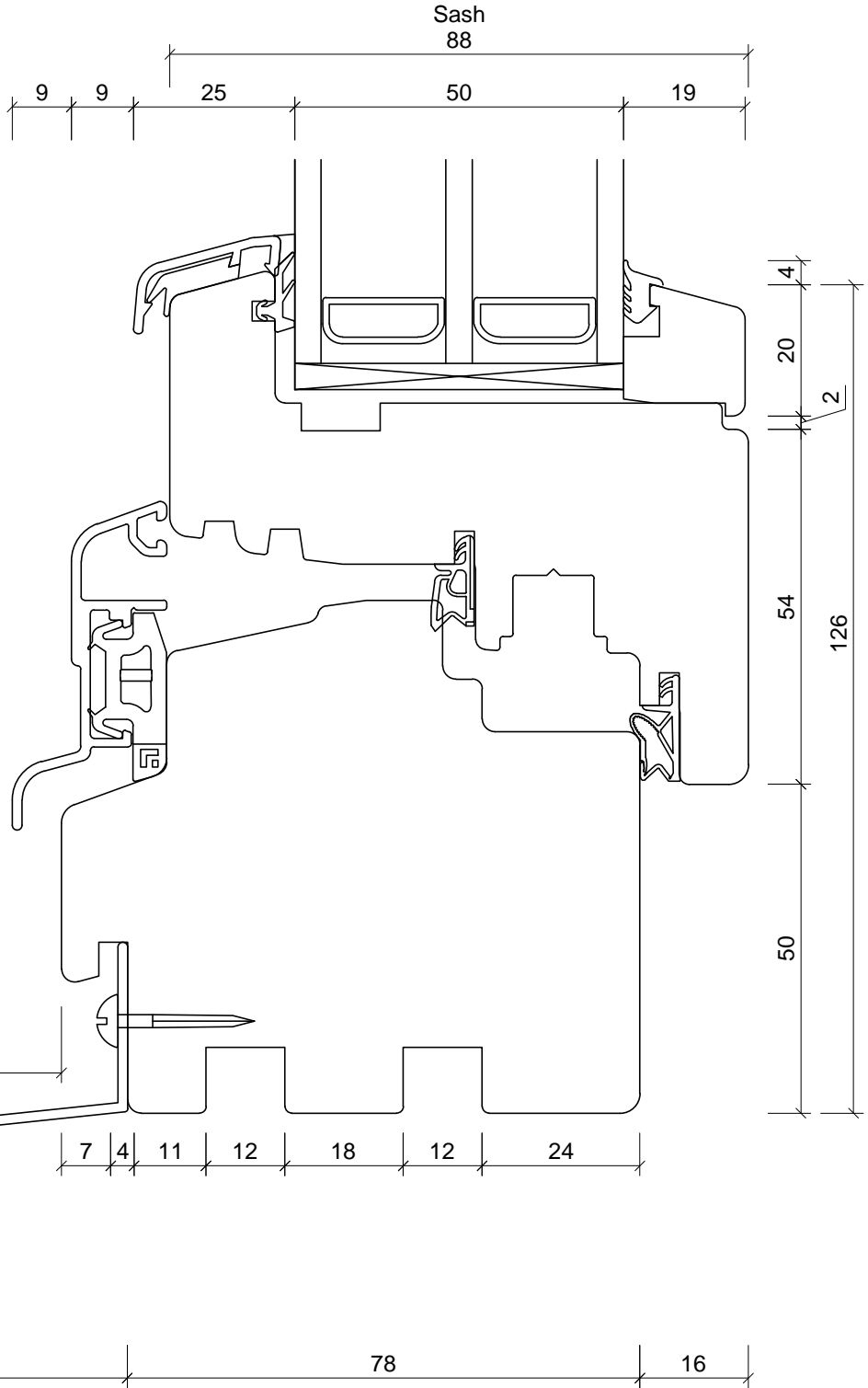

Unit 6  
Ticehurst Yard  
Tostock  
Bury St Edmunds  
Suffolk  
IP30 9PH  
  
Tel: 01359 272 646  
sales@livingwoodwindows.co.uk  
www.livingwoodwindows.co.uk

Unit Type:

LW88  
Triple Glazed Timber  
Tilt & Turn Window

Drawing Title:

Section Through Sill  
Optional Aluminium Sill Extension

Drawing No.:  
LW88-209

Date:  
28/02/13

Drawn By:  
JSE

Scale:  
NTS

This drawing remains the property of Livingwood Windows Ltd and may not be reproduced without written permission. Livingwood Windows Ltd accepts no liability arising from any party acting on information contained within this drawing. It is advised that assistance is sought from Livingwood Windows Ltd regarding matters of an individual project.