

Unit 6
Ticehurst Yard
Tostock
Bury St Edmunds
Suffolk
IP30 9PH

Tel: 01359 272 646
sales@livingwoodwindows.co.uk
www.livingwoodwindows.co.uk

Unit Type:
FD12
Double Glazed Timber
French Doors

Drawing Title:
Section Through Threshold
Outward Opening Doors

Drawing No.:
FD12-101

Date:
28/02/13

Drawn By:
JSE

Scale:
NTS

This drawing remains the property of Livingwood Windows Ltd and may not be reproduced without written permission. Livingwood Windows Ltd accepts no liability arising from any party acting on information contained within this drawing. It is advised that assistance is sought from Livingwood Windows Ltd regarding matters of an individual project.

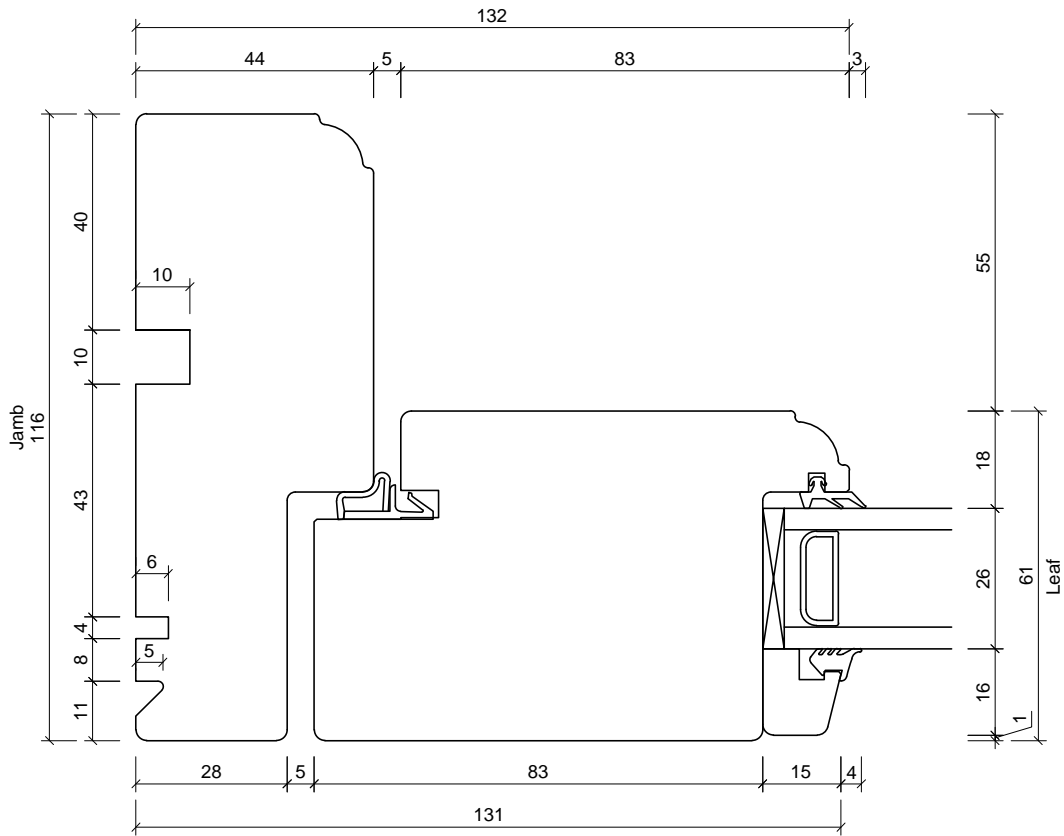
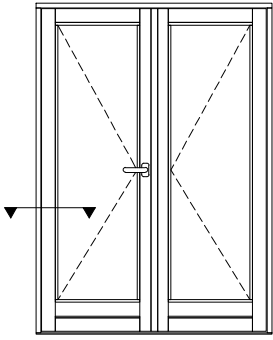

Unit 6
Ticehurst Yard
Tostock
Bury St Edmunds
Suffolk
IP30 9PH

Tel: 01359 272 646
sales@livingwoodwindows.co.uk
www.livingwoodwindows.co.uk

Unit Type:	FD12 Double Glazed Timber French Doors	Drawing No.: FD12-102
		Date: 28/02/13
Drawing Title:	Section Through Jamb Outward Opening Doors	Drawn By: JSE
		Scale: NTS
<small>This drawing remains the property of Livingwood Windows Ltd and may not be reproduced without written permission. Livingwood Windows Ltd accepts no liability arising from any party acting on information contained within this drawing. It is advised that assistance is sought from Livingwood Windows Ltd regarding matters of an individual project.</small>		

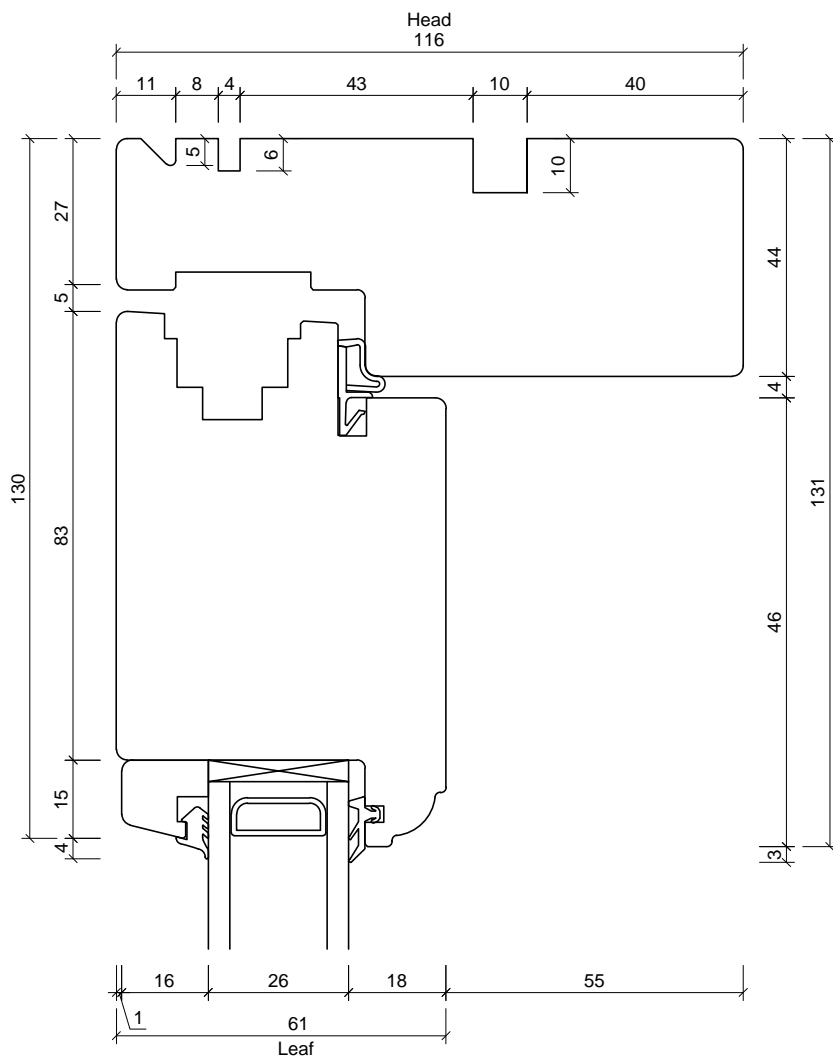
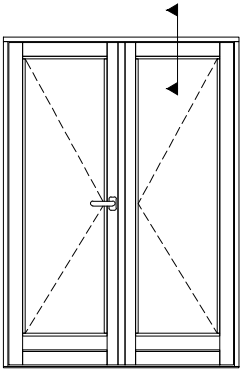

Unit 6
Ticehurst Yard
Tostock
Bury St Edmunds
Suffolk
IP30 9PH

Tel: 01359 272 646
sales@livingwoodwindows.co.uk
www.livingwoodwindows.co.uk

Unit Type:	FD12 Double Glazed Timber French Doors	Drawing No.:	FD12-103
		Date:	28/02/13
Drawing Title:	Section Through Head Outward Opening Doors	Drawn By:	JSE
		Scale:	NTS
<small>This drawing remains the property of Livingwood Windows Ltd and may not be reproduced without written permission. Livingwood Windows Ltd accepts no liability arising from any party acting on information contained within this drawing. It is advised that assistance is sought from Livingwood Windows Ltd regarding matters of an individual project.</small>			

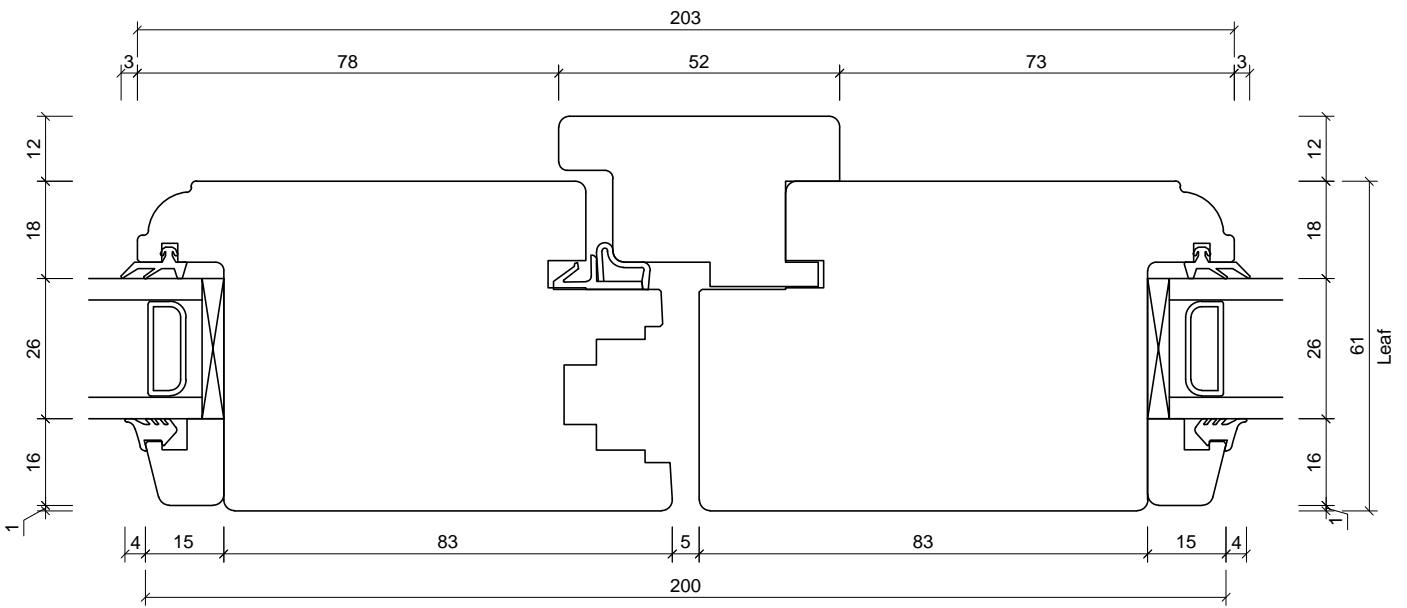
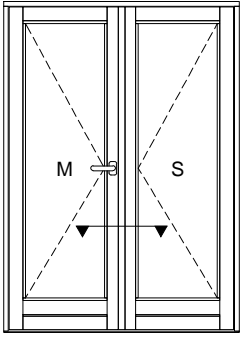

Unit 6
Ticehurst Yard
Tostock
Bury St Edmunds
Suffolk
IP30 9PH

Tel: 01359 272 646
sales@livingwoodwindows.co.uk
www.livingwoodwindows.co.uk

Unit Type:
FD12
Double Glazed Timber
French Doors

Drawing Title:
Section Through Centre
Primary Leaf/Secondary Leaf
Outward Opening Doors

Drawing No.:
FD12-104

Date:
28/02/13

Drawn By:
JSE

Scale:
NTS

This drawing remains the property of Livingwood Windows Ltd and may not be reproduced without written permission. Livingwood Windows Ltd accepts no liability arising from any party acting on information contained within this drawing. It is advised that assistance is sought from Livingwood Windows Ltd regarding matters of an individual project.

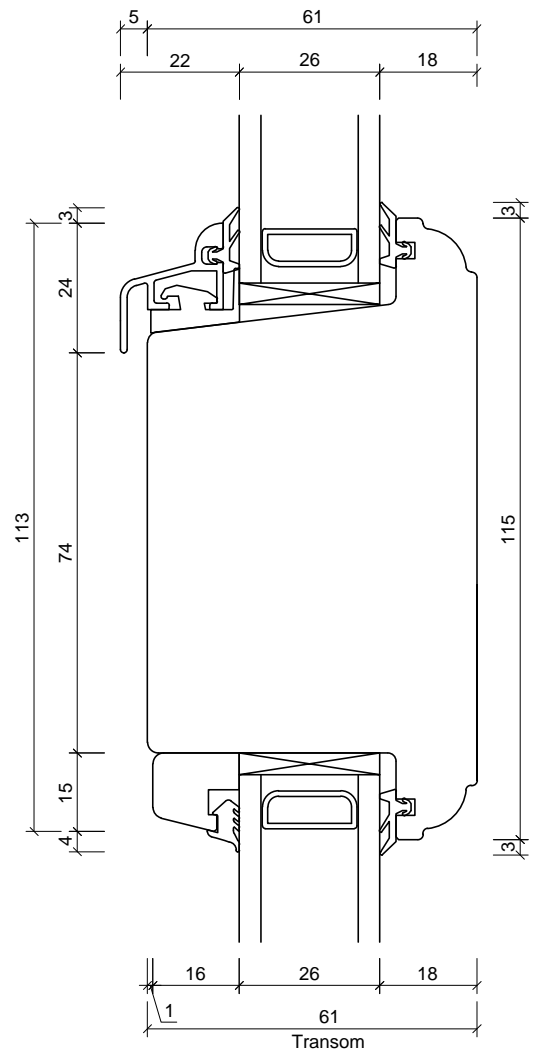
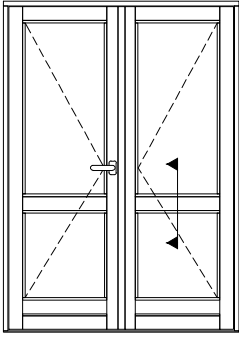

Unit 6
Ticehurst Yard
Tostock
Bury St Edmunds
Suffolk
IP30 9PH

Tel: 01359 272 646
sales@livingwoodwindows.co.uk
www.livingwoodwindows.co.uk

Unit Type:	FD12 Double Glazed Timber French Doors	Drawing No.: FD12-105
		Date: 28/02/13
Drawing Title:	Section Through Transom Inward and Outward Opening Doors	Drawn By: JSE
		Scale: NTS

This drawing remains the property of Livingwood Windows Ltd and may not be reproduced without written permission. Livingwood Windows Ltd accepts no liability arising from any party acting on information contained within this drawing. It is advised that assistance is sought from Livingwood Windows Ltd regarding matters of an individual project.

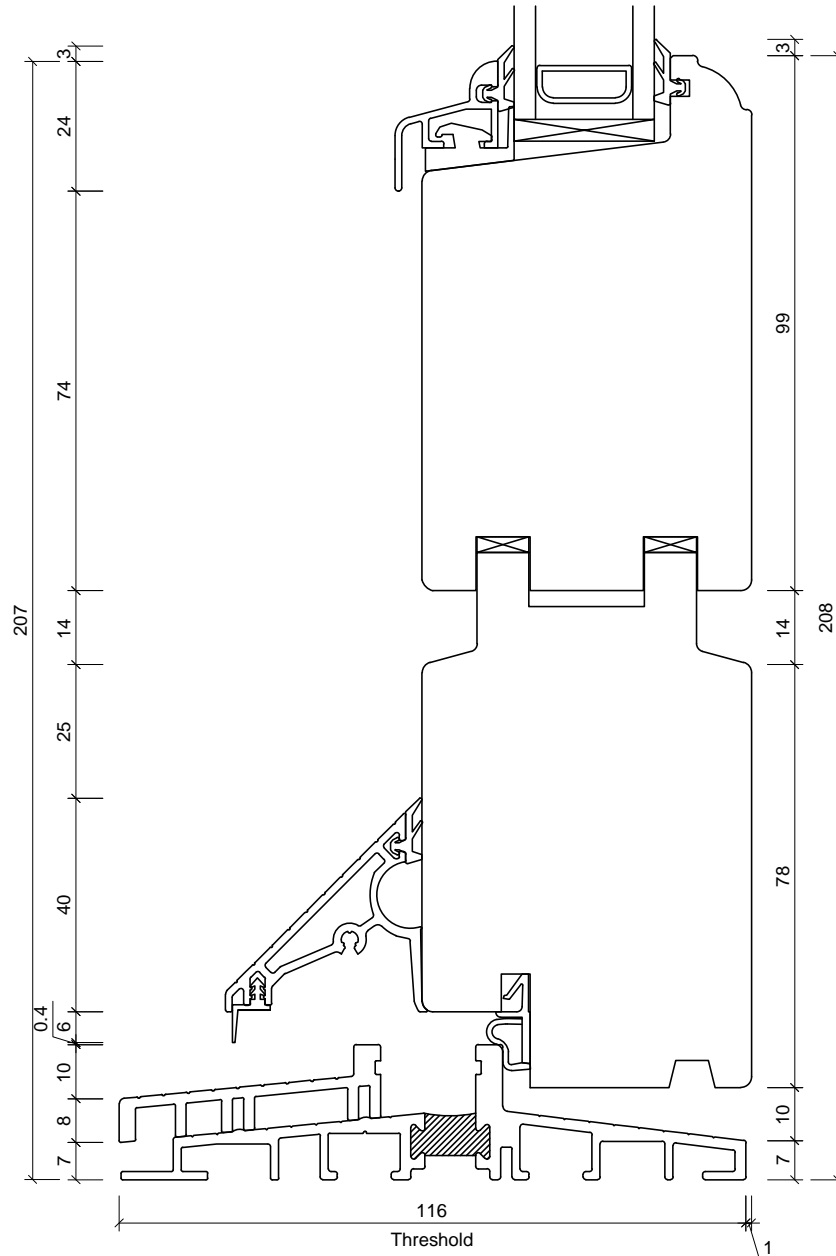
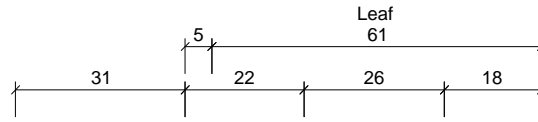
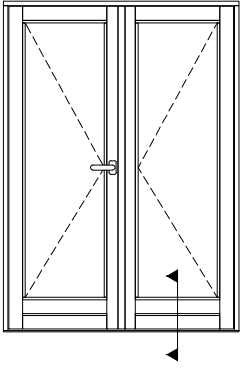

Unit 6
Ticehurst Yard
Tostock
Bury St Edmunds
Suffolk
IP30 9PH

Tel: 01359 272 646
sales@livingwoodwindows.co.uk
www.livingwoodwindows.co.uk

Unit Type:
FD12
Double Glazed Timber
French Doors

Drawing Title:
Section Through Threshold
Inward Opening Doors

Drawing No.:
FD12-106

Date:
28/02/13

Drawn By:
JSE

Scale:
NTS

This drawing remains the property of Livingwood Windows Ltd and may not be reproduced without written permission. Livingwood Windows Ltd accepts no liability arising from any party acting on information contained within this drawing. It is advised that assistance is sought from Livingwood Windows Ltd regarding matters of an individual project.

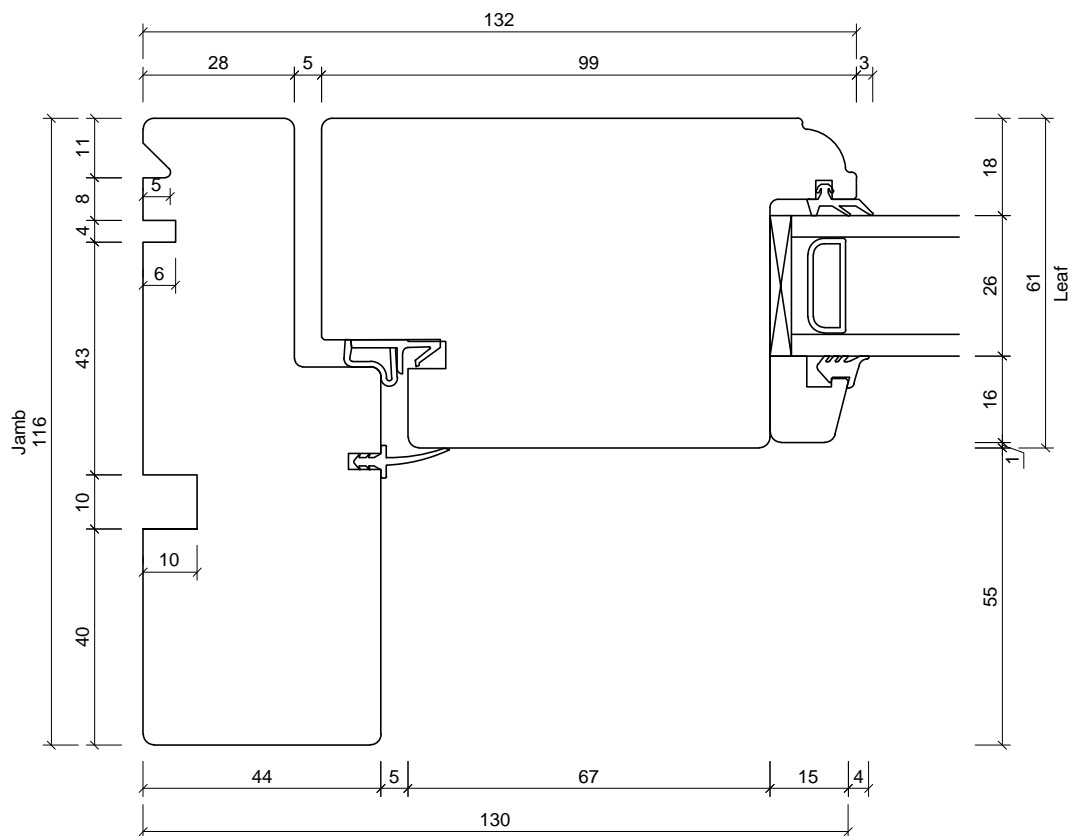
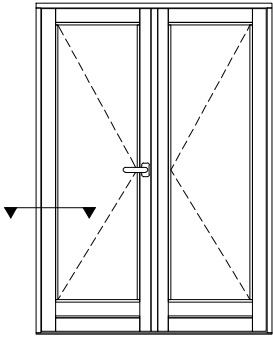

Unit 6
Ticehurst Yard
Tostock
Bury St Edmunds
Suffolk
IP30 9PH

Tel: 01359 272 646
sales@livingwoodwindows.co.uk
www.livingwoodwindows.co.uk

Unit Type:	FD12 Double Glazed Timber French Doors	Drawing No.: FD12-107
		Date: 28/02/13
Drawing Title:	Section Through Jamb Inward Opening Doors	Drawn By: JSE
		Scale: NTS
<small>This drawing remains the property of Livingwood Windows Ltd and may not be reproduced without written permission. Livingwood Windows Ltd accepts no liability arising from any party acting on information contained within this drawing. It is advised that assistance is sought from Livingwood Windows Ltd regarding matters of an individual project.</small>		

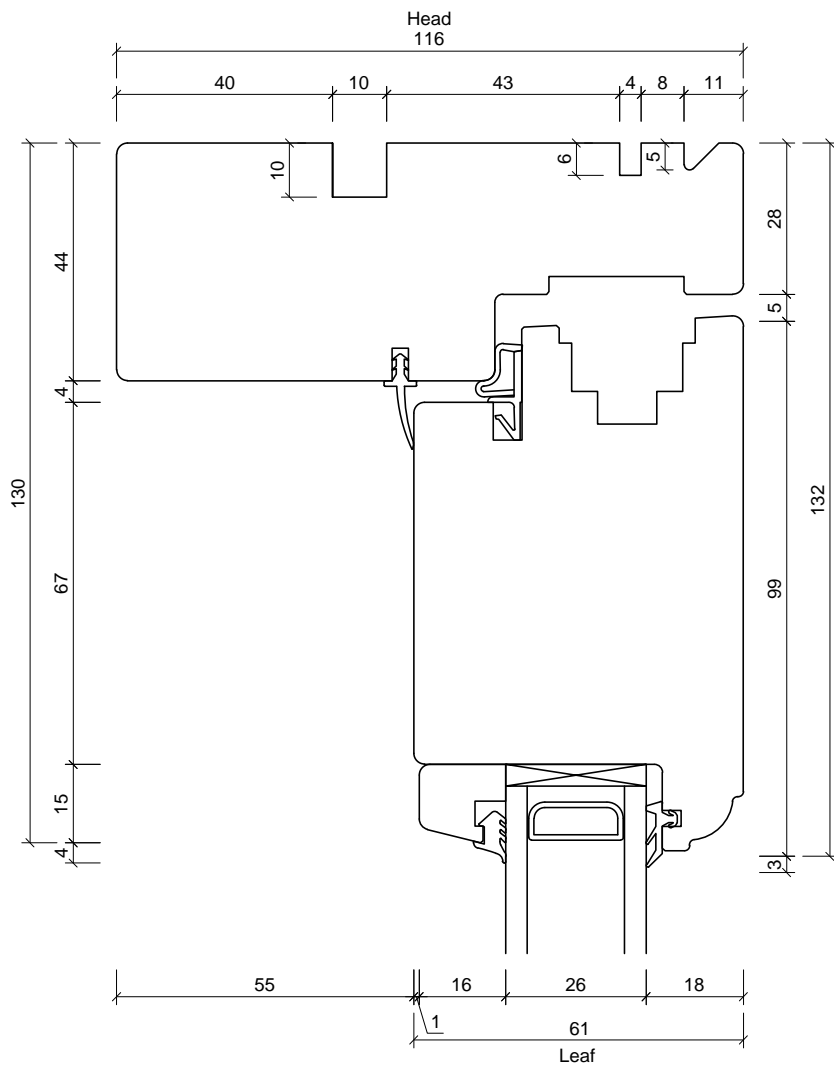
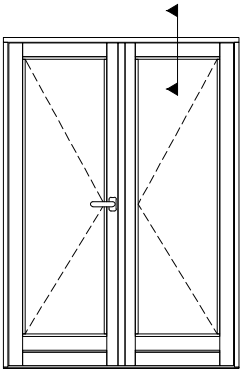

Unit 6
Ticehurst Yard
Tostock
Bury St Edmunds
Suffolk
IP30 9PH

Tel: 01359 272 646
sales@livingwoodwindows.co.uk
www.livingwoodwindows.co.uk

Unit Type:
FD12
Double Glazed Timber
French Doors

Drawing Title:
Section Through Head
Inward Opening Doors

Drawing No.:
FD12-108

Date:
28/02/13

Drawn By:
JSE

Scale:
NTS

This drawing remains the property of Livingwood Windows Ltd and may not be reproduced without written permission. Livingwood Windows Ltd accepts no liability arising from any party acting on information contained within this drawing. It is advised that assistance is sought from Livingwood Windows Ltd regarding matters of an individual project.

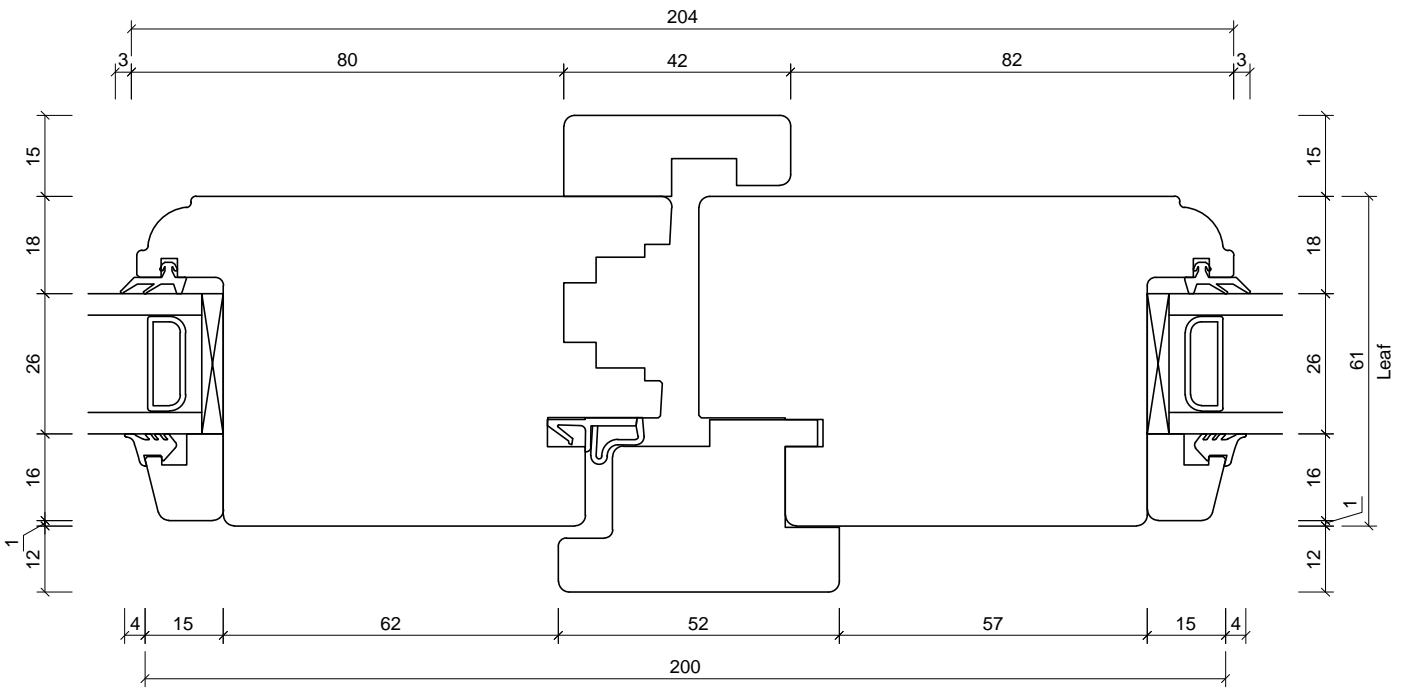
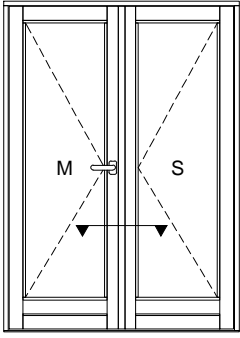

Unit 6
Ticehurst Yard
Tostock
Bury St Edmunds
Suffolk
IP30 9PH

Tel: 01359 272 646
sales@livingwoodwindows.co.uk
www.livingwoodwindows.co.uk

Unit Type:
FD12
Double Glazed Timber
French Doors

Drawing Title:
Section Through Centre
Primary Leaf/Secondary Leaf
Inward Opening Doors

Drawing No.:
FD12-109

Date:
28/02/13

Drawn By:
JSE

Scale:
NTS

This drawing remains the property of Livingwood Windows Ltd and may not be reproduced without written permission. Livingwood Windows Ltd accepts no liability arising from any party acting on information contained within this drawing. It is advised that assistance is sought from Livingwood Windows Ltd regarding matters of an individual project.