

Studio 5
 Old School Studios
 140 Eastgate Street
 Bury St Edmunds
 Suffolk
 IP33 1XX
 Tel: 01284 705 468
 sales@livingwoodwindows.co.uk
 www.livingwoodwindows.co.uk

Drawing No.:
 V-2TLS101

Date:
 06.09.11

Drawing Title:
 2k Timber Lift & Slide Door
 Section Through Threshold
 Fixed Screen/Opening Screen

Drawn By:
 JSE

Scale:
 NTS

This drawing remains the property of Livingwood Windows Ltd and may not be reproduced without written permission.
 Livingwood Windows Ltd accepts no liability arising from any party acting on information contained within this drawing.
 It is advised that assistance is sought from Livingwood windows Ltd regarding matters of an individual project.

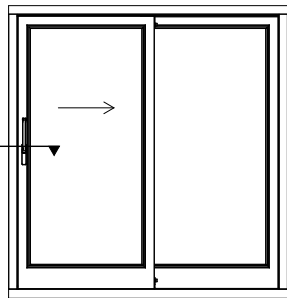
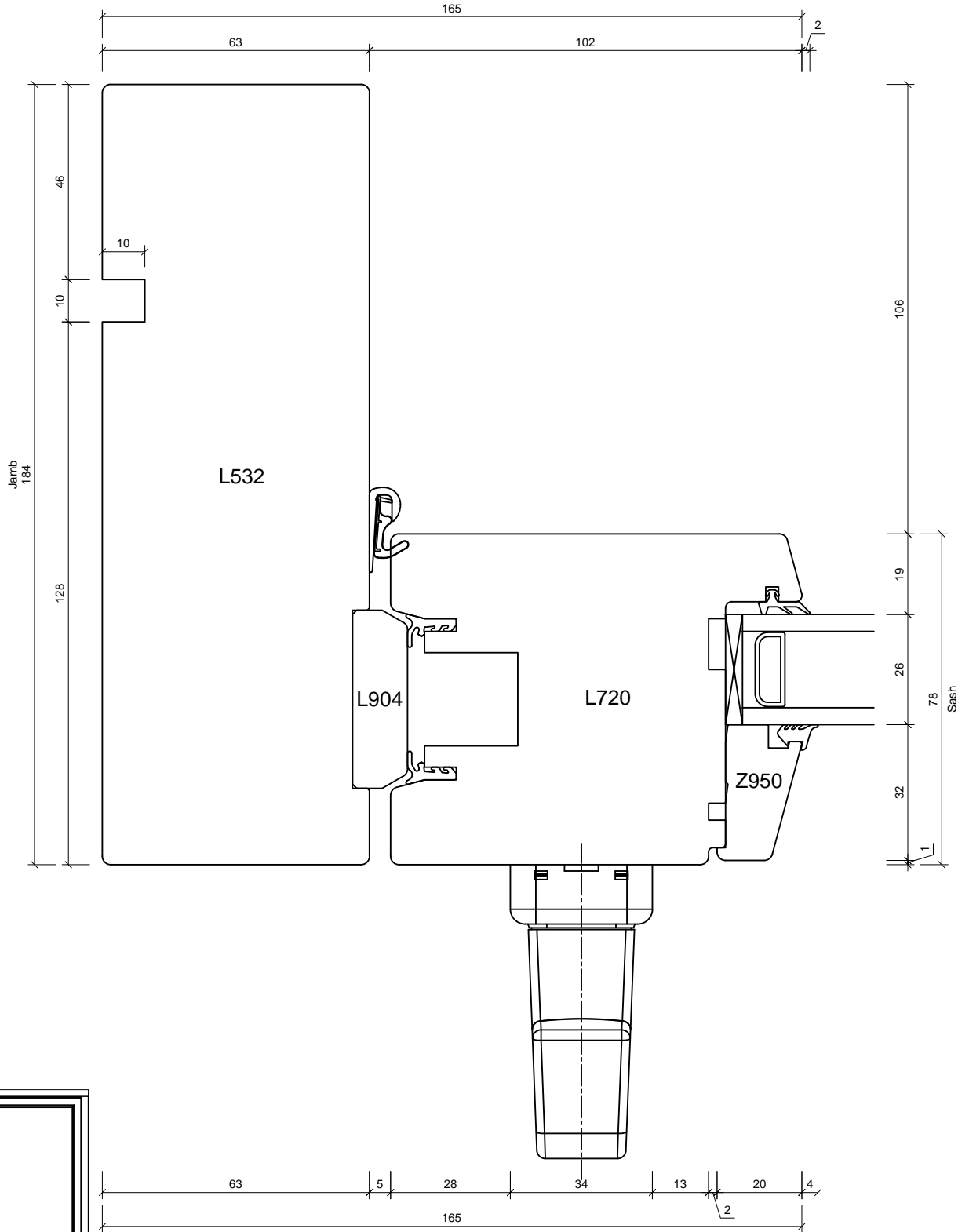

Studio 5
 Old School Studios
 140 Eastgate Street
 Bury St Edmunds
 Suffolk
 IP33 1XX
 Tel: 01284 705 468
 sales@livingwoodwindows.co.uk
 www.livingwoodwindows.co.uk

Drawing No.: V-2TLS102	Date: 06.09.11
Drawing Title: 2k Timber Lift & Slide Door Section Through Jamb Opening Screen	Drawn By: JSE
	Scale: NTS
<small>This drawing remains the property of Livingwood Windows Ltd and may not be reproduced without written permission. Livingwood Windows Ltd accepts no liability arising from any party acting on information contained within this drawing. It is advised that assistance is sought from Livingwood windows Ltd regarding matters of an individual project.</small>	

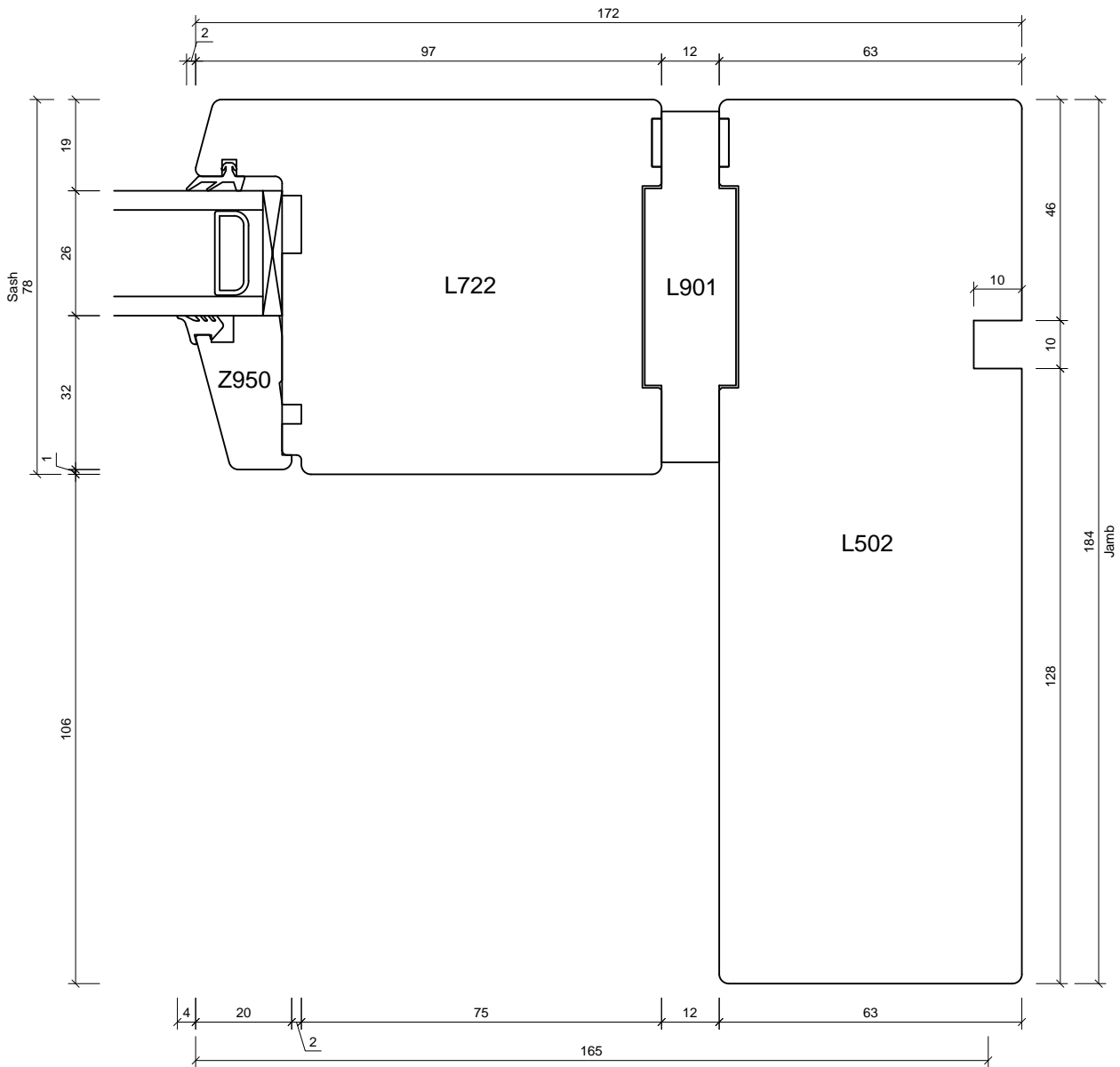
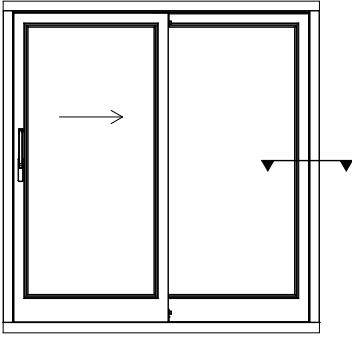

Studio 5
 Old School Studios
 140 Eastgate Street
 Bury St Edmunds
 Suffolk
 IP33 1XX
 Tel: 01284 705 468
 sales@livingwoodwindows.co.uk
 www.livingwoodwindows.co.uk

Drawing No.:	V-2TLS103	Date:	06.09.11
Drawing Title:	2k Timber Lift & Slide Door Section Through Jamb Fixed Screen	Drawn By:	JSE
		Scale:	NTS

This drawing remains the property of Livingwood Windows Ltd and may not be reproduced without written permission.
 Livingwood Windows Ltd accepts no liability arising from any party acting on information contained within this drawing.
 It is advised that assistance is sought from Livingwood windows Ltd regarding matters of an individual project.

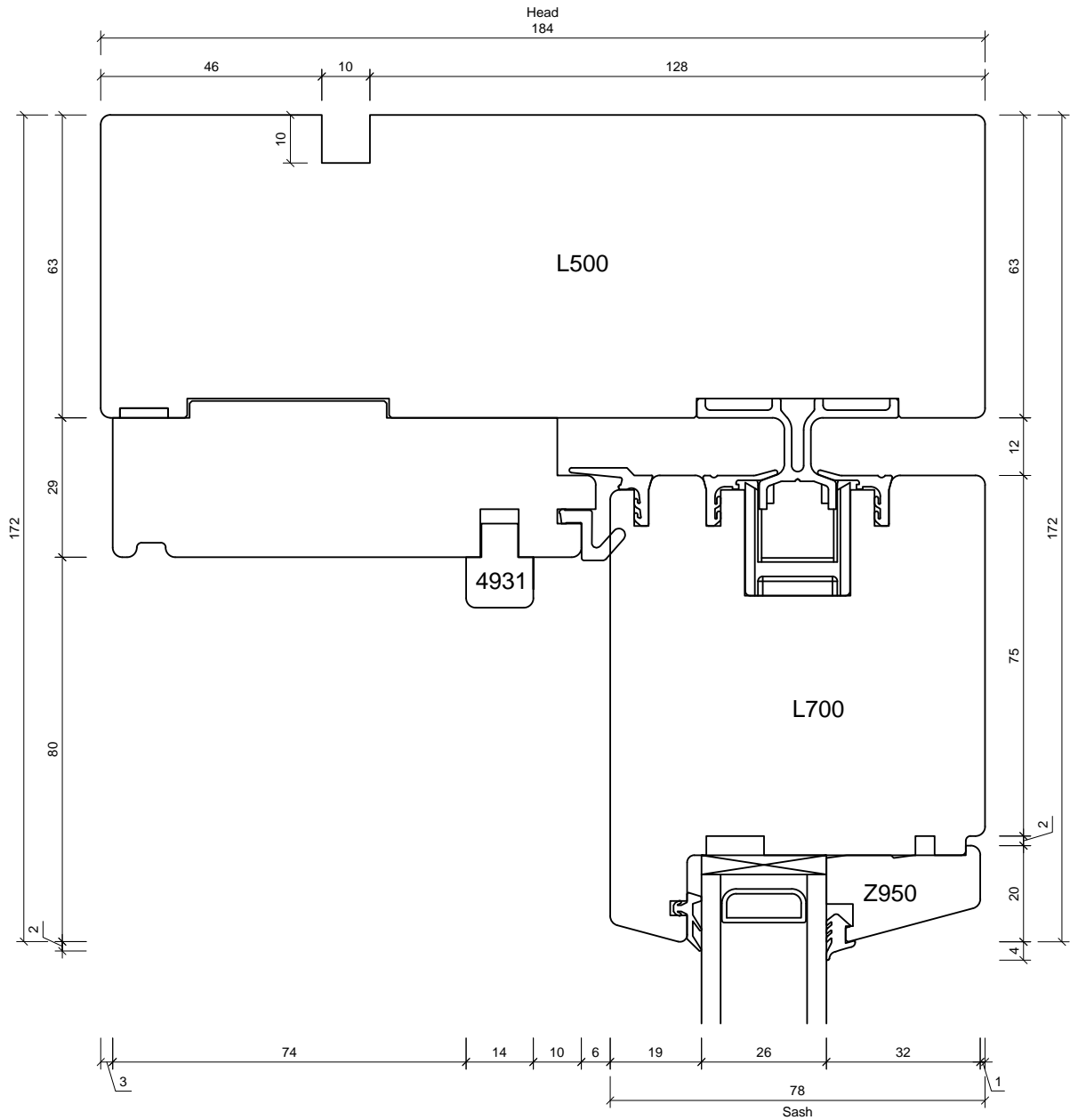
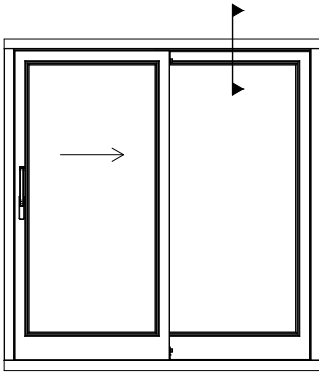

Studio 5
 Old School Studios
 140 Eastgate Street
 Bury St Edmunds
 Suffolk
 IP33 1XX
 Tel: 01284 705 468
 sales@livingwoodwindows.co.uk
 www.livingwoodwindows.co.uk

Drawing No.:	V-2TLS104	Date:	06.09.11
Drawing Title:	2k Timber Lift & Slide Door Section Through Head Opening Screen	Drawn By:	JSE
		Scale:	NTS

This drawing remains the property of Livingwood Windows Ltd and may not be reproduced without written permission.
 Livingwood Windows Ltd accepts no liability arising from any party acting on information contained within this drawing.
 It is advised that assistance is sought from Livingwood windows Ltd regarding matters of an individual project.

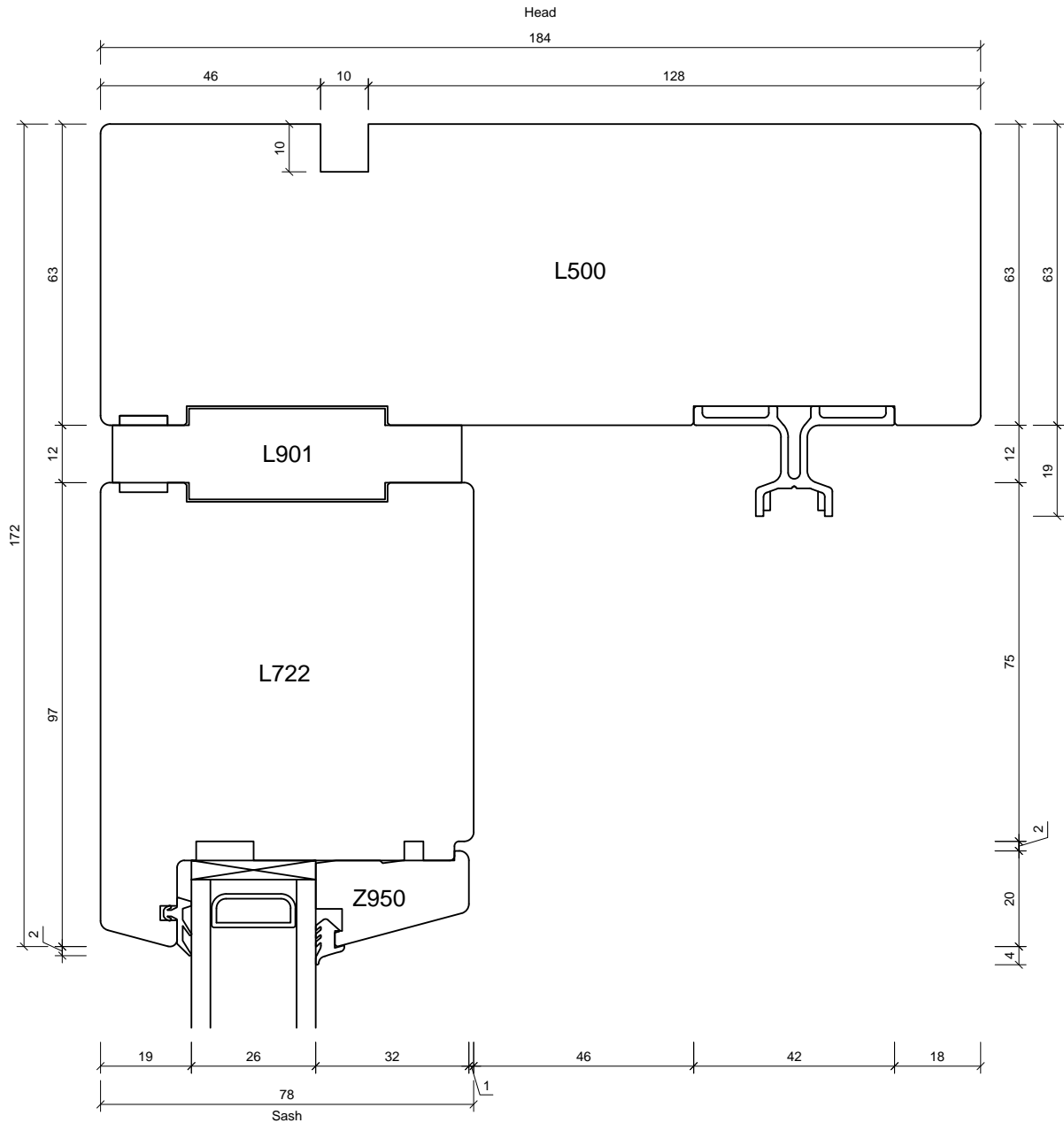
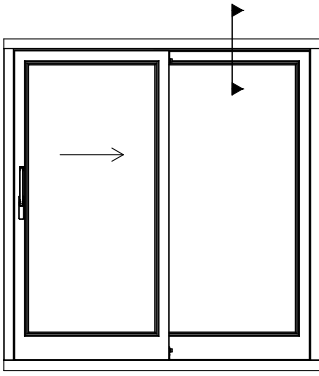

Studio 5
Old School Studios
140 Eastgate Street
Bury St Edmunds
Suffolk
IP33 1XX
Tel: 01284 705 468
sales@livingwoodwindows.co.uk
www.livingwoodwindows.co.uk

Drawing No.: V-2TLS105	Date: 06.09.11
Drawing Title: 2k Timber Lift & Slide Door Section Through Head Fixed Screen	Drawn By: JSE
	Scale: NTS
<small>This drawing remains the property of Livingwood Windows Ltd and may not be reproduced without written permission. Livingwood Windows Ltd accepts no liability arising from any party acting on information contained within this drawing. It is advised that assistance is sought from Livingwood windows Ltd regarding matters of an individual project.</small>	

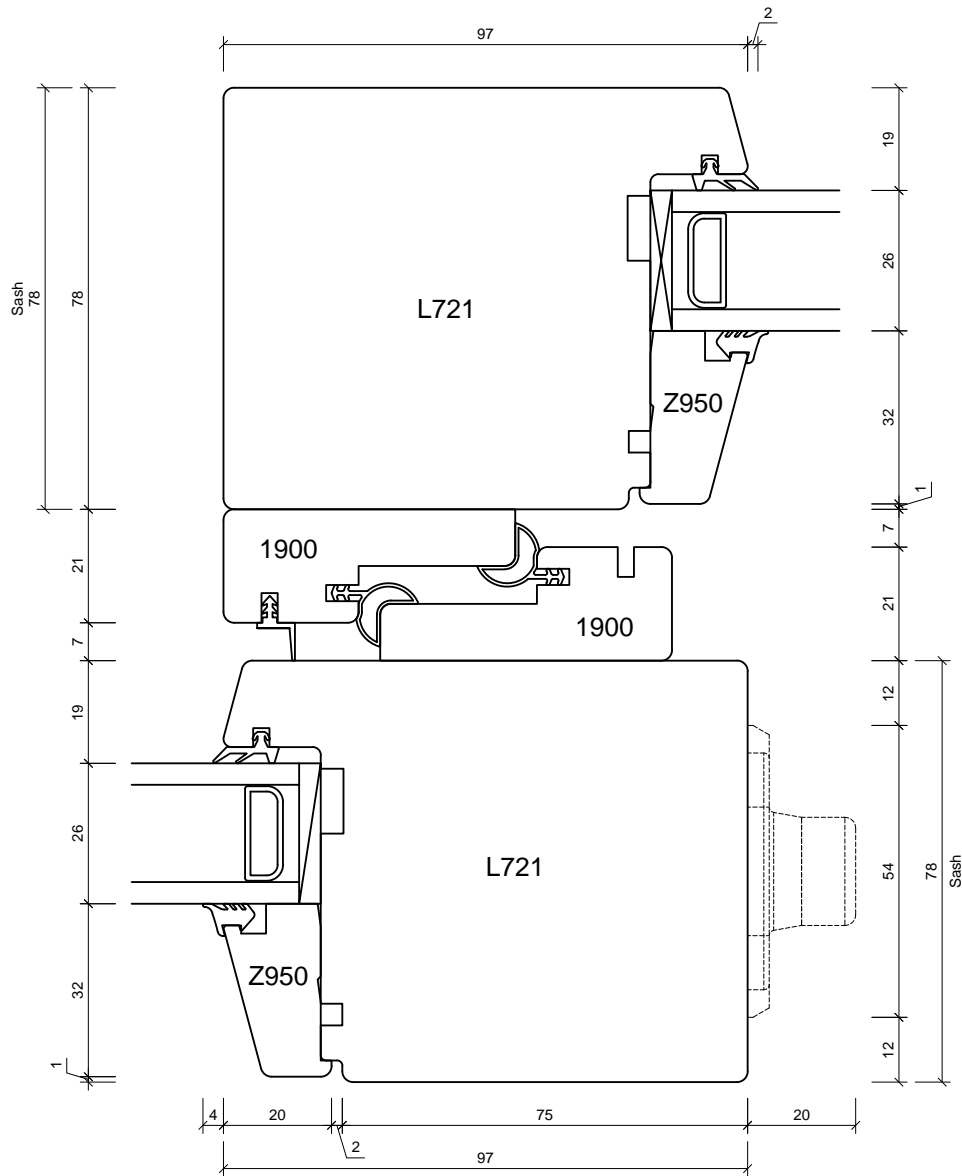
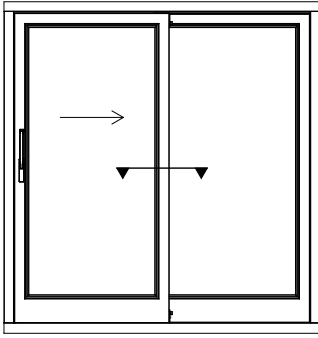

Studio 5
 Old School Studios
 140 Eastgate Street
 Bury St Edmunds
 Suffolk
 IP33 1XX
 Tel: 01284 705 468
 sales@livingwoodwindows.co.uk
 www.livingwoodwindows.co.uk

Drawing No.:	V-2TLS106	Date:	06.09.11
Drawing Title:	2k Timber Lift & Slide Door Section Through Centre Opening Screen/Fixed Screen	Drawn By:	JSE
		Scale:	NTS
<small>This drawing remains the property of Livingwood Windows Ltd and may not be reproduced without written permission. Livingwood Windows Ltd accepts no liability arising from any party acting on information contained within this drawing. It is advised that assistance is sought from Livingwood windows Ltd regarding matters of an individual project.</small>			

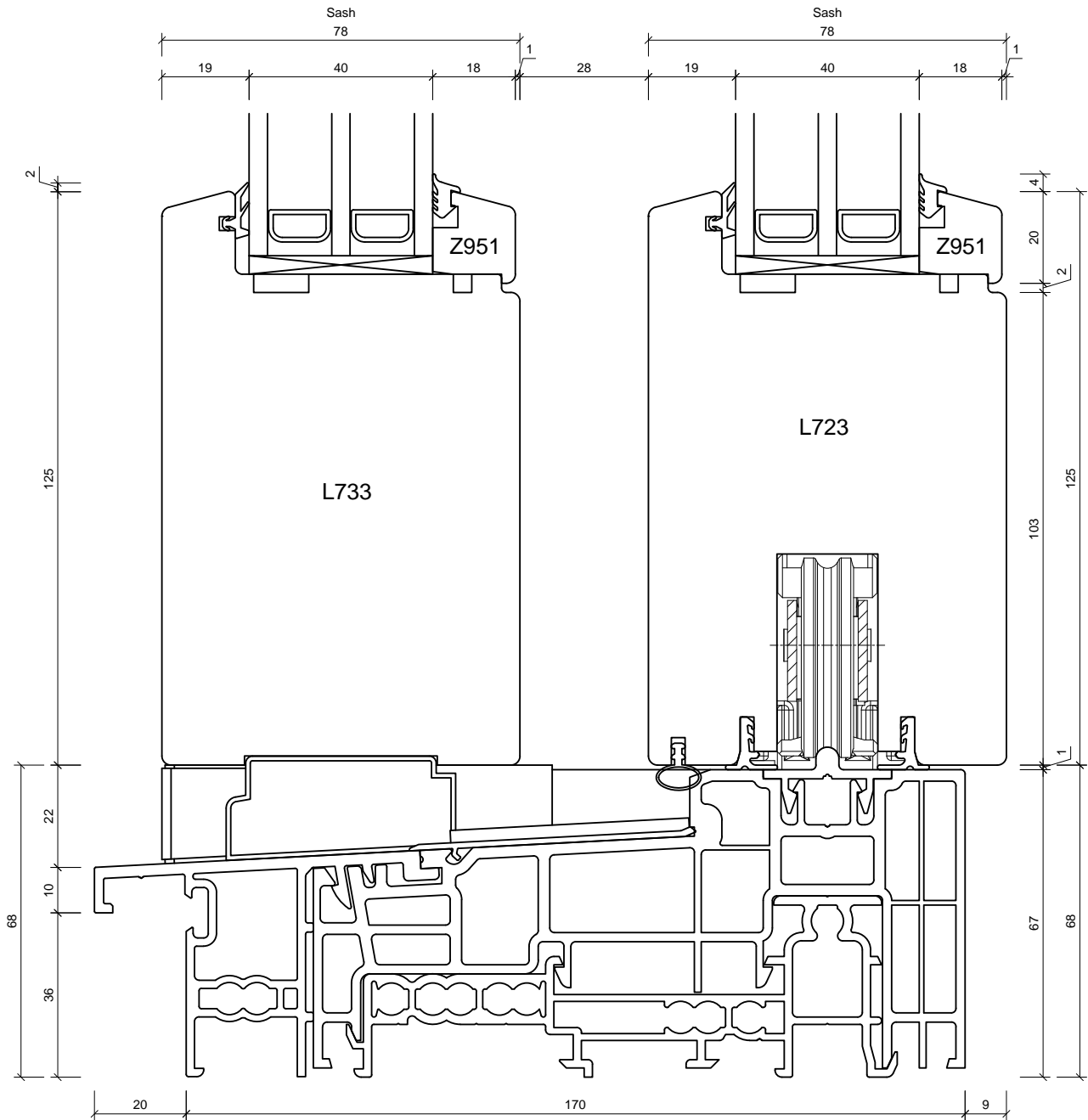
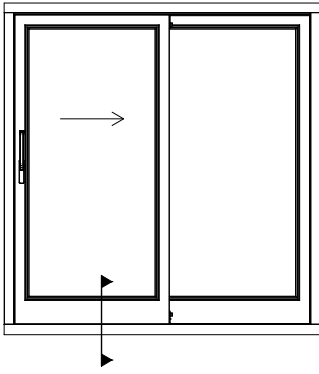

Studio 5
 Old School Studios
 140 Eastgate Street
 Bury St Edmunds
 Suffolk
 IP33 1XX
 Tel: 01284 705 468
 sales@livingwoodwindows.co.uk
 www.livingwoodwindows.co.uk

Drawing No.:
 V-3TLS101

Date:
 06.09.11

Drawing Title:
 3k Timber Lift & Slide Door
 Section Through Threshold
 Fixed Screen/Opening Screen

Drawn By:
 JSE

Scale:
 NTS

This drawing remains the property of Livingwood Windows Ltd and may not be reproduced without written permission. Livingwood Windows Ltd accepts no liability arising from any party acting on information contained within this drawing. It is advised that assistance is sought from Livingwood windows Ltd regarding matters of an individual project.

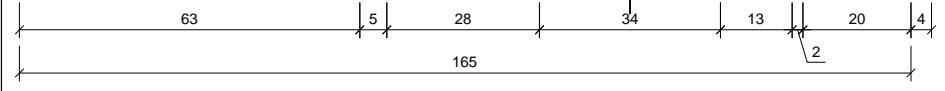
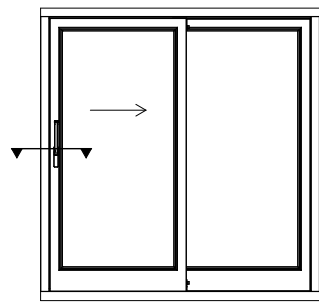
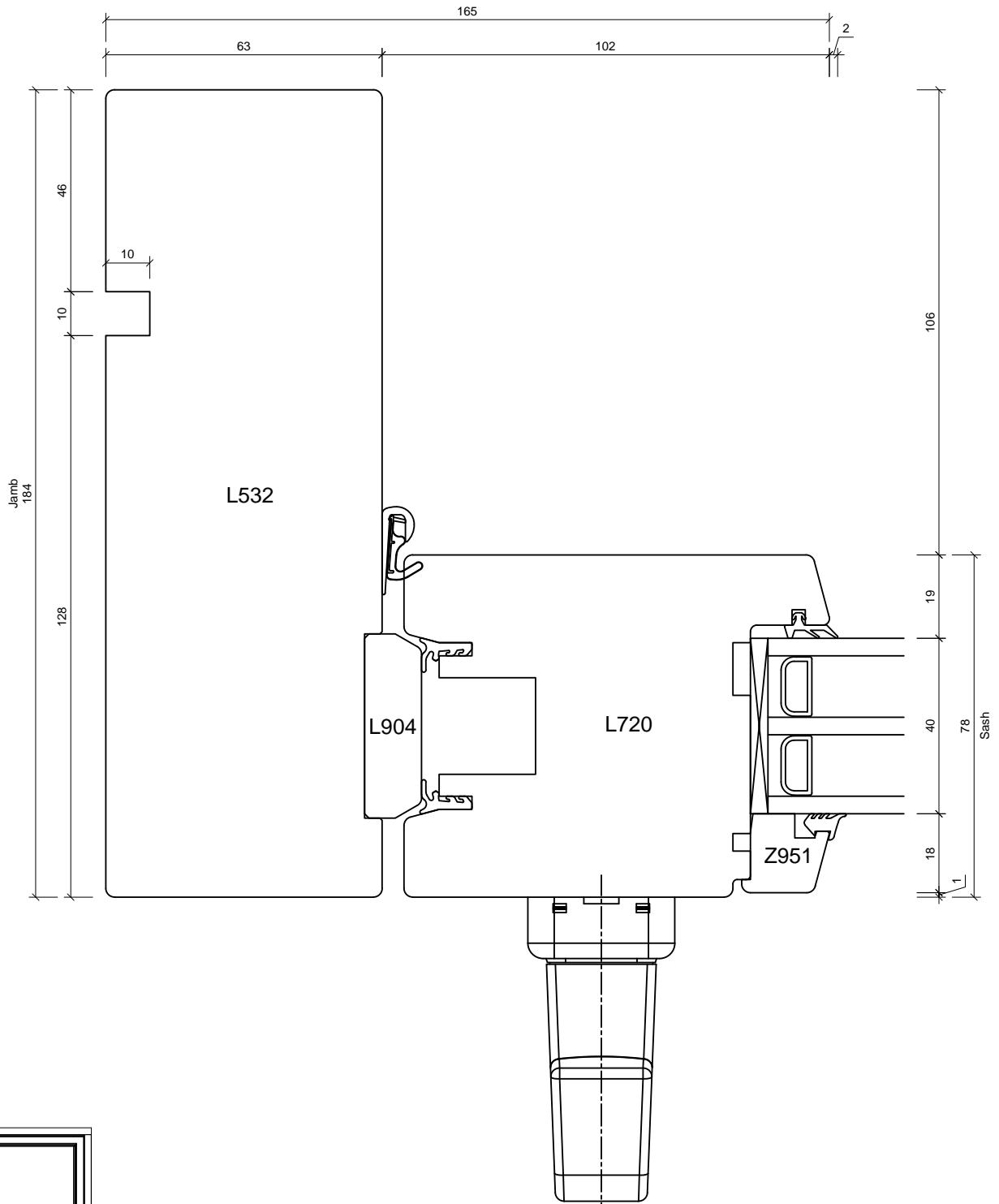

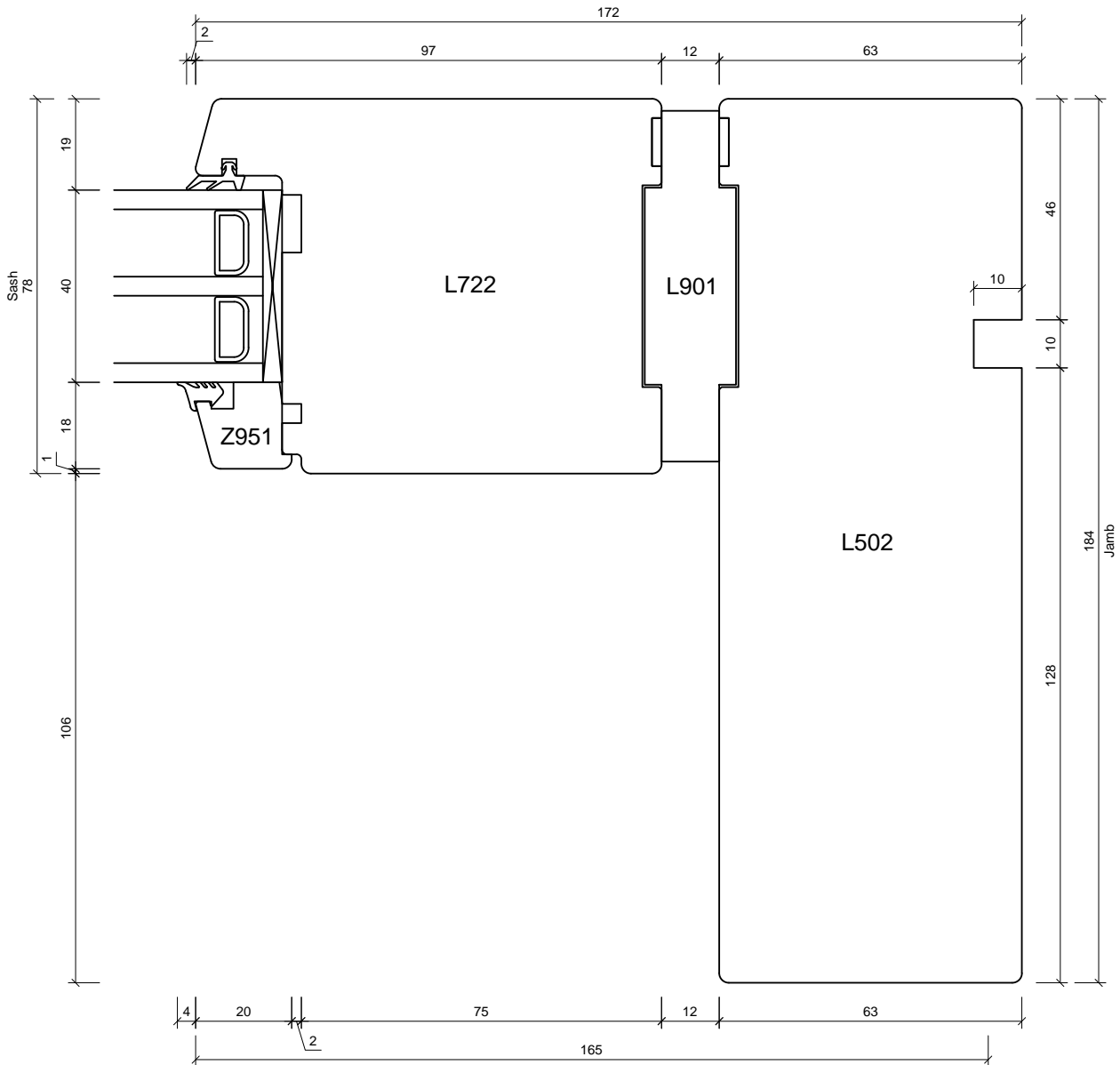
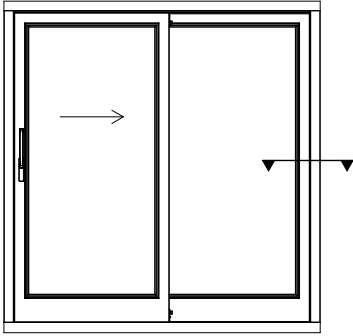

Studio 5
 Old School Studios
 140 Eastgate Street
 Bury St Edmunds
 Suffolk
 IP33 1XX
 Tel: 01284 705 468
 sales@livingwoodwindows.co.uk
 www.livingwoodwindows.co.uk

Drawing No.:	V-3TLS102	Date:	06.09.11
Drawing Title:	3k Timber Lift & Slide Door Section Through Jamb Opening Screen	Drawn By:	JSE
		Scale:	NTS
<small>This drawing remains the property of Livingwood Windows Ltd and may not be reproduced without written permission. Livingwood Windows Ltd accepts no liability arising from any party acting on information contained within this drawing. It is advised that assistance is sought from Livingwood windows Ltd regarding matters of an individual project.</small>			

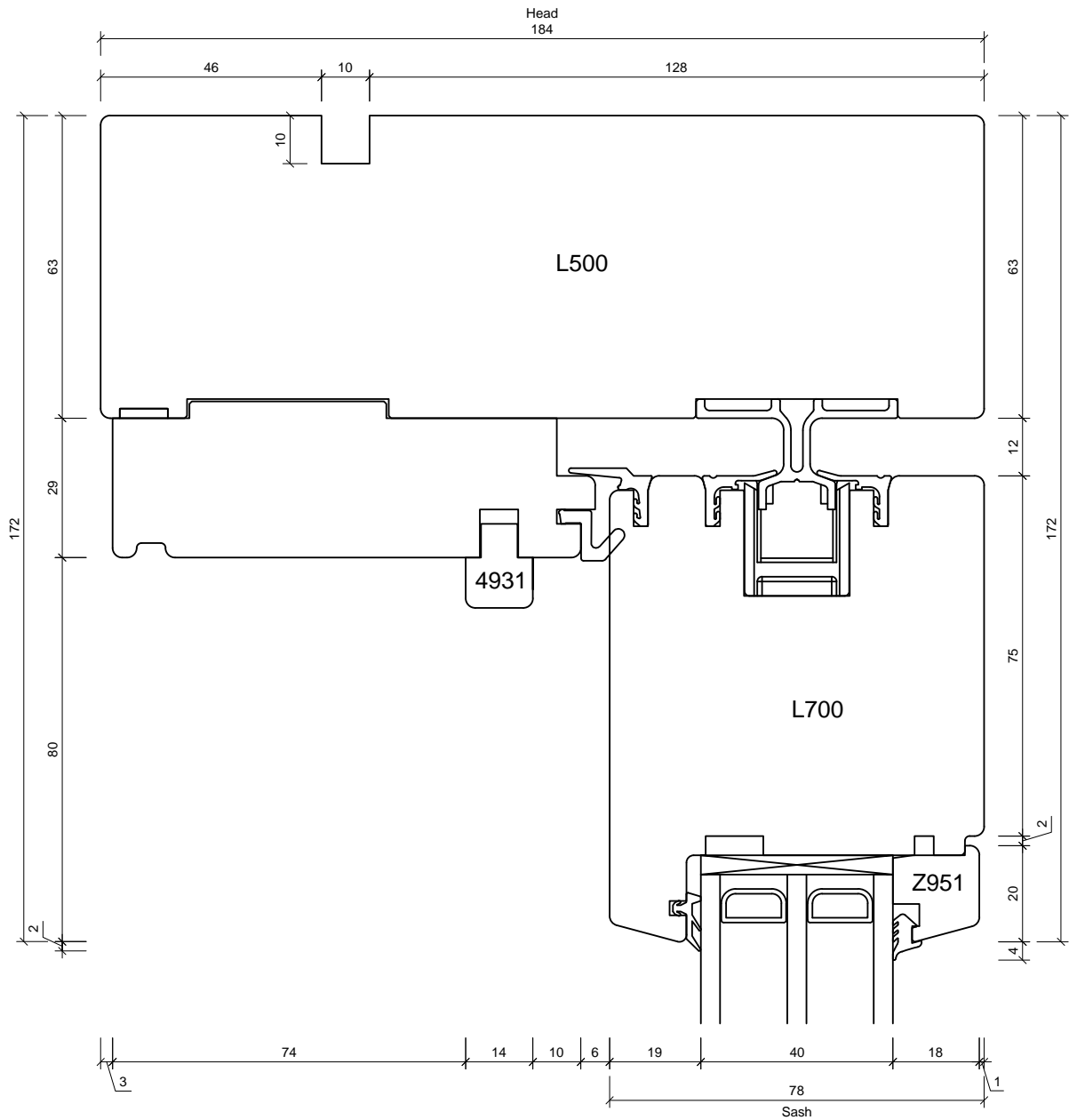
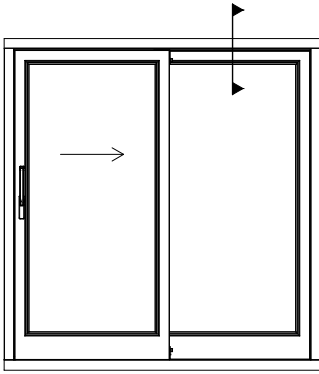

Studio 5
 Old School Studios
 140 Eastgate Street
 Bury St Edmunds
 Suffolk
 IP33 1XX
 Tel: 01284 705 468
 sales@livingwoodwindows.co.uk
 www.livingwoodwindows.co.uk

Drawing No.: V-3TLS103	Date: 06.09.11
Drawing Title: 3k Timber Lift & Slide Door Section Through Jamb Fixed Screen	Drawn By: JSE
	Scale: NTS
<small>This drawing remains the property of Livingwood Windows Ltd and may not be reproduced without written permission. Livingwood Windows Ltd accepts no liability arising from any party acting on information contained within this drawing. It is advised that assistance is sought from Livingwood windows Ltd regarding matters of an individual project.</small>	



Studio 5
 Old School Studios
 140 Eastgate Street
 Bury St Edmunds
 Suffolk
 IP33 1XX
 Tel: 01284 705 468
 sales@livingwoodwindows.co.uk
 www.livingwoodwindows.co.uk

Drawing No.:	V-3TLS104	Date:	06.09.11
Drawing Title:	3k Timber Lift & Slide Door Section Through Head Opening Screen	Drawn By:	JSE
		Scale:	NTS

This drawing remains the property of Livingwood Windows Ltd and may not be reproduced without written permission. Livingwood Windows Ltd accepts no liability arising from any party acting on information contained within this drawing. It is advised that assistance is sought from Livingwood windows Ltd regarding matters of an individual project.

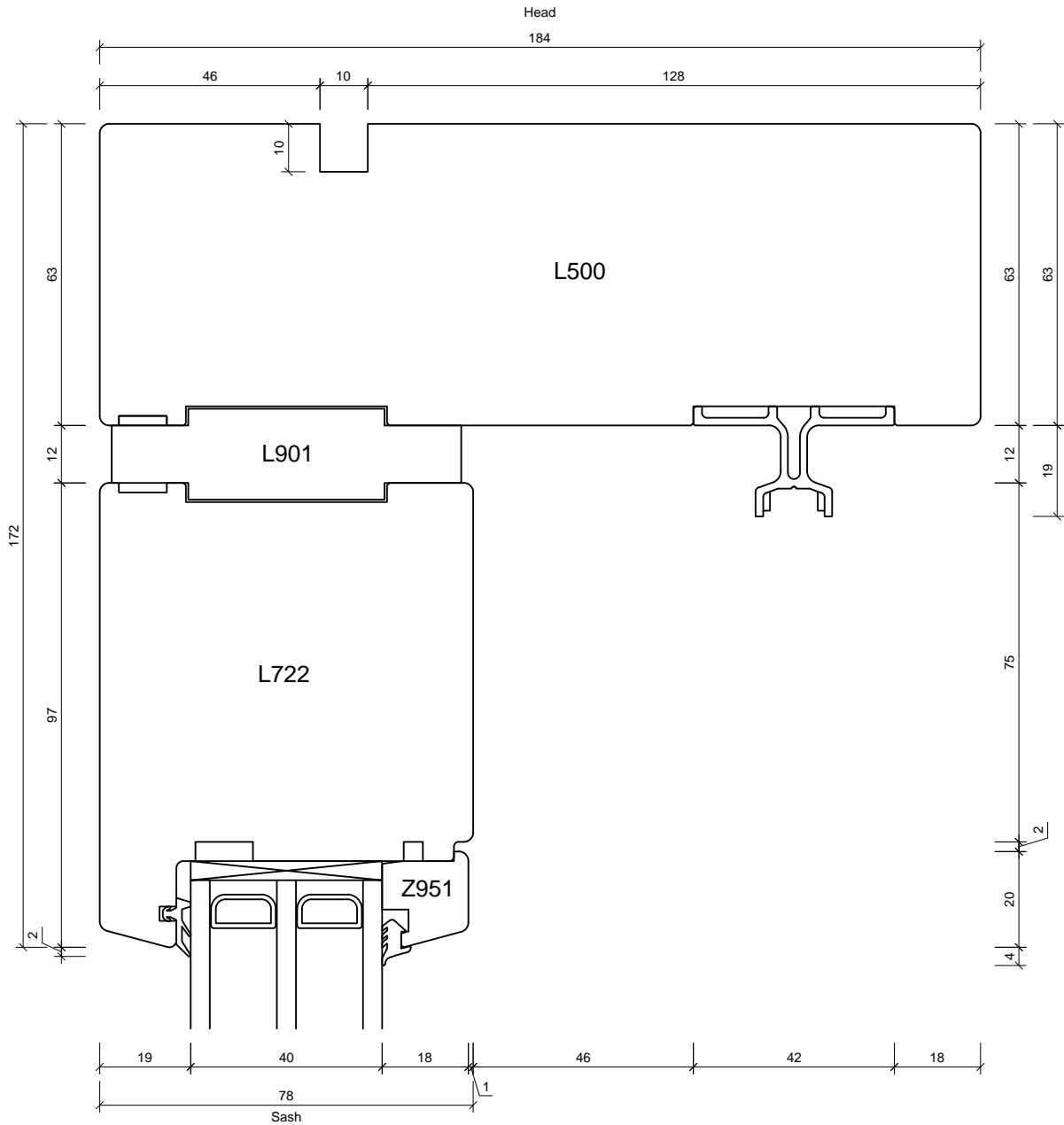
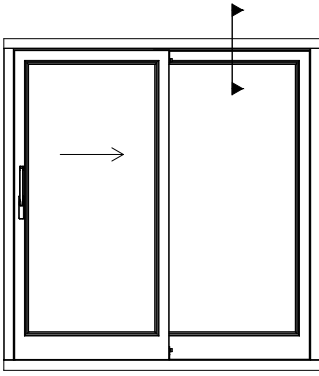

Studio 5
 Old School Studios
 140 Eastgate Street
 Bury St Edmunds
 Suffolk
 IP33 1XX
 Tel: 01284 705 468
 sales@livingwoodwindows.co.uk
 www.livingwoodwindows.co.uk

Drawing No.: V-3TLS105	Date: 06.09.11
Drawing Title: 3k Timber Lift & Slide Door Section Through Head Fixed Screen	Drawn By: JSE
	Scale: NTS

This drawing remains the property of Livingwood Windows Ltd and may not be reproduced without written permission.
 Livingwood Windows Ltd accepts no liability arising from any party acting on information contained within this drawing.
 It is advised that assistance is sought from Livingwood windows Ltd regarding matters of an individual project.

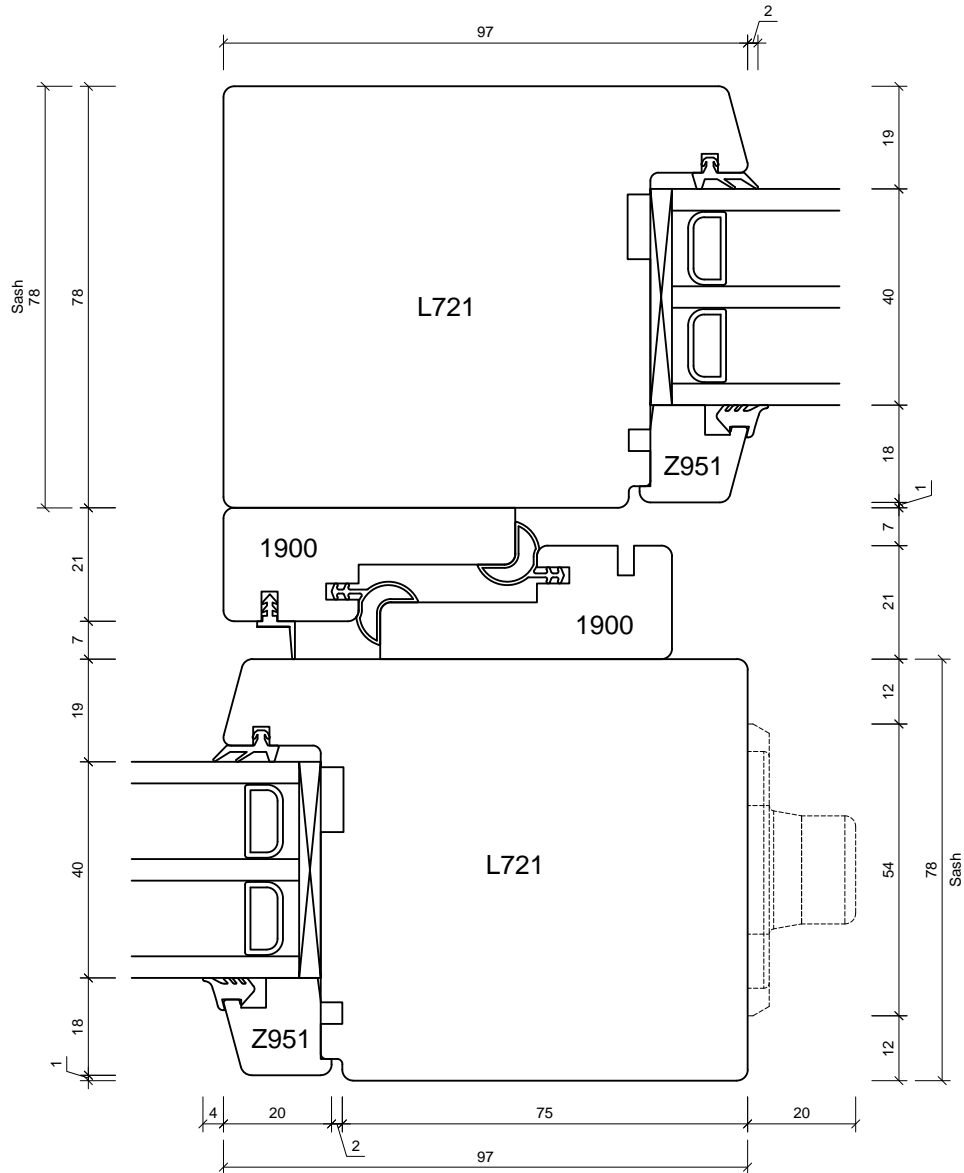
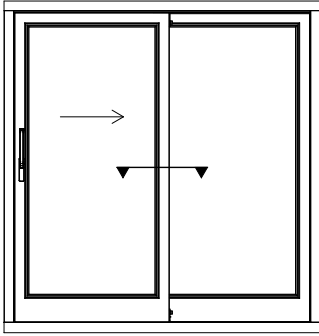

Studio 5
 Old School Studios
 140 Eastgate Street
 Bury St Edmunds
 Suffolk
 IP33 1XX
 Tel: 01284 705 468
 sales@livingwoodwindows.co.uk
 www.livingwoodwindows.co.uk

Drawing No.: V-3TLS106	Date: 06.09.11
Drawing Title: 3k Timber Lift & Slide Door Section Through Centre Opening Screen/Fixed Screen	Drawn By: JSE
	Scale: NTS
<small>This drawing remains the property of Livingwood Windows Ltd and may not be reproduced without written permission. Livingwood Windows Ltd accepts no liability arising from any party acting on information contained within this drawing. It is advised that assistance is sought from Livingwood windows Ltd regarding matters of an individual project.</small>	

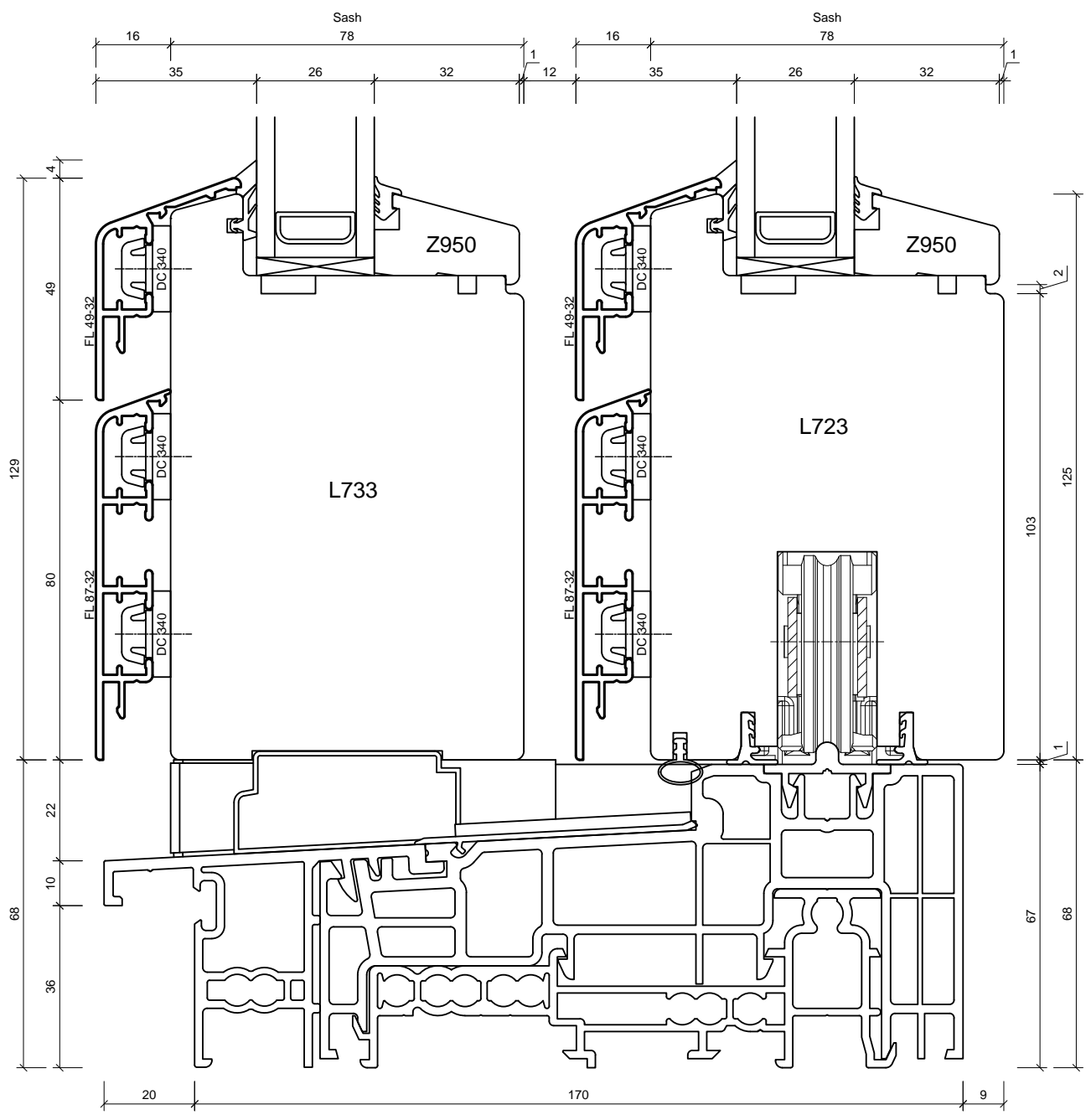
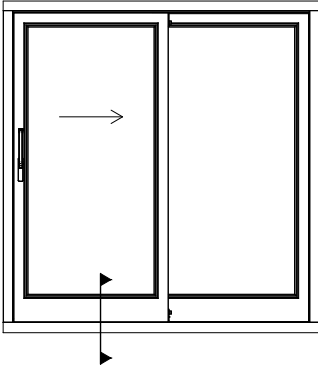

Studio 5
 Old School Studios
 140 Eastgate Street
 Bury St Edmunds
 Suffolk
 IP33 1XX
 Tel: 01284 705 468
 sales@livingwoodwindows.co.uk
 www.livingwoodwindows.co.uk

Drawing No.:	V-2ACLS101	Date:	06.09.11
Drawing Title:	2k Alu-Clad Lift & Slide Door Section Through Threshold Fixed Screen/Opening Screen	Drawn By:	JSE
		Scale:	NTS
<small>This drawing remains the property of Livingwood Windows Ltd and may not be reproduced without written permission. Livingwood Windows Ltd accepts no liability arising from any party acting on information contained within this drawing. It is advised that assistance is sought from Livingwood windows Ltd regarding matters of an individual project.</small>			

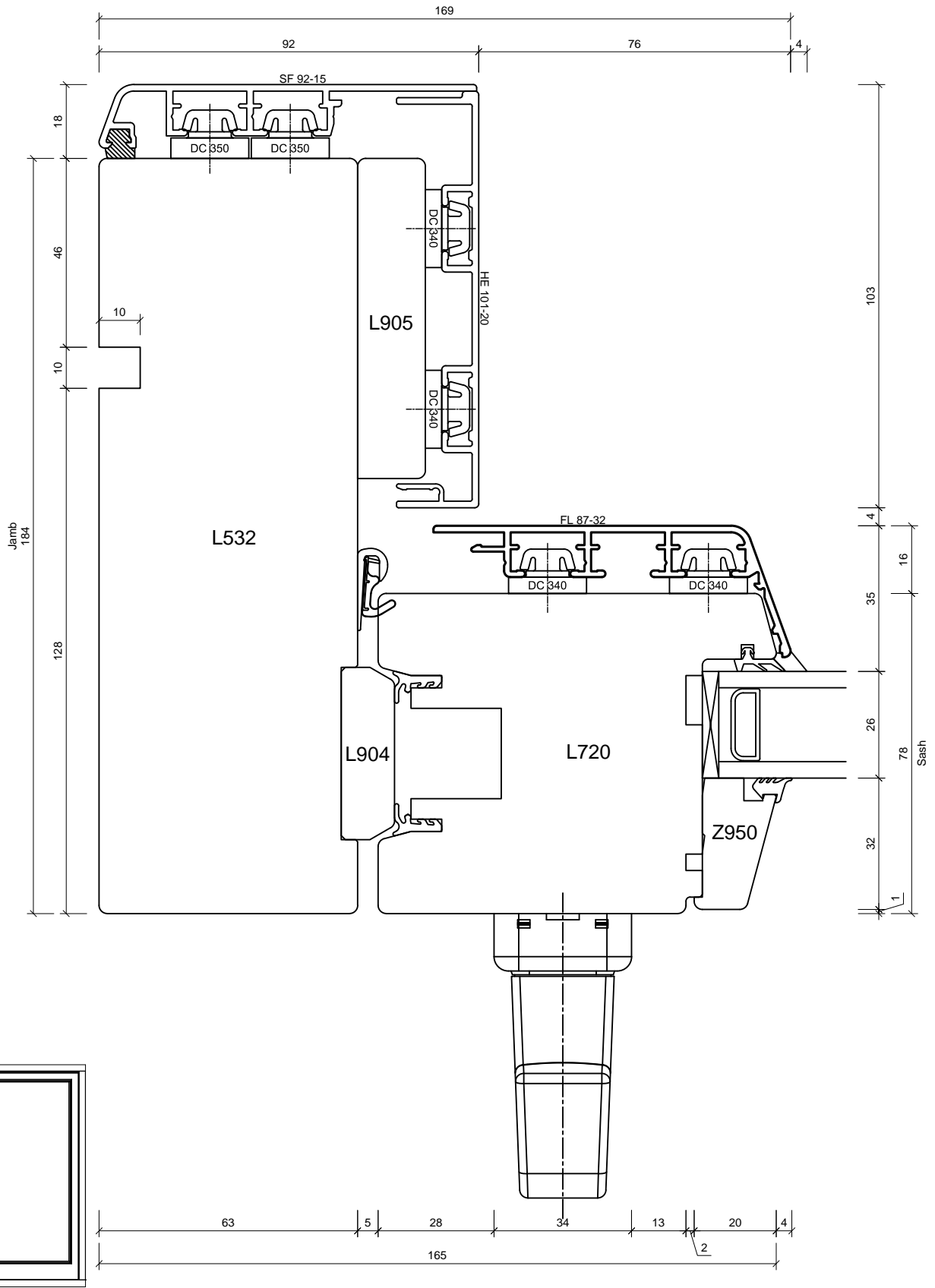

livingwood
 windows Ltd

Studio 5
 Old School Studios
 140 Eastgate Street
 Bury St Edmunds
 Suffolk
 IP33 1XX
 Tel: 01284 705 468
 sales@livingwoodwindows.co.uk
 www.livingwoodwindows.co.uk

Drawing No.:	V-2ACLS102	Date:	06.09.11
Drawing Title:	2k Alu-Clad Lift & Slide Door Section Through Jamb Opening Screen	Drawn By:	JSE
		Scale:	NTS
<small>This drawing remains the property of Livingwood Windows Ltd and may not be reproduced without written permission. Livingwood Windows Ltd accepts no liability arising from any party acting on information contained within this drawing. It is advised that assistance is sought from Livingwood windows Ltd regarding matters of an individual project.</small>			

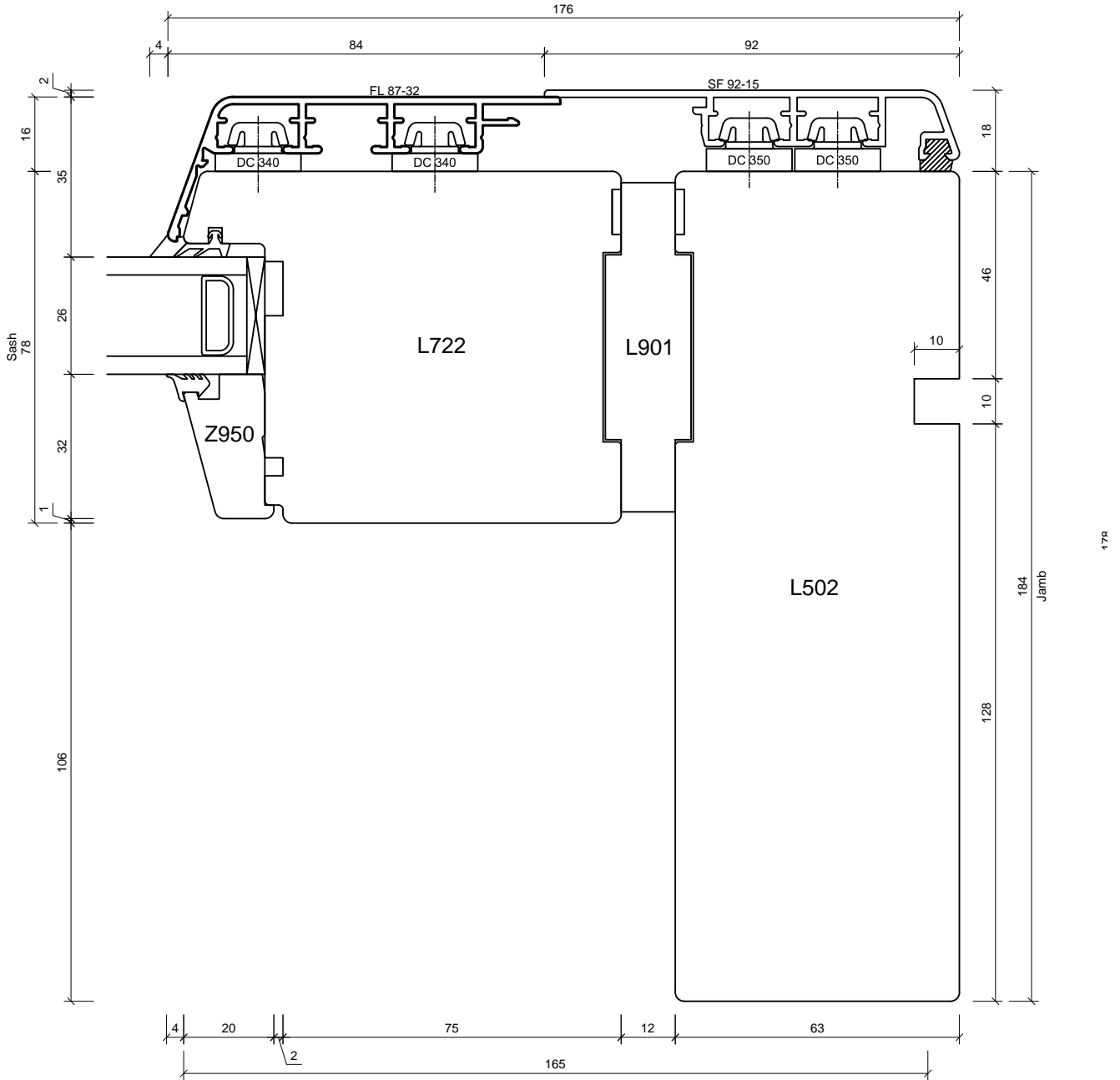
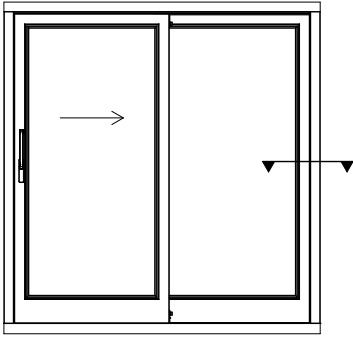

Studio 5
 Old School Studios
 140 Eastgate Street
 Bury St Edmunds
 Suffolk
 IP33 1XX
 Tel: 01284 705 468
 sales@livingwoodwindows.co.uk
 www.livingwoodwindows.co.uk

Drawing No.:	V-2ACLS103	Date:	06.09.11
Drawing Title:	2k Alu-Clad Lift & Slide Door Section Through Jamb Fixed Screen	Drawn By:	JSE
		Scale:	NTS

This drawing remains the property of Livingwood Windows Ltd and may not be reproduced without written permission. Livingwood Windows Ltd accepts no liability arising from any party acting on information contained within this drawing. It is advised that assistance is sought from Livingwood windows Ltd regarding matters of an individual project.

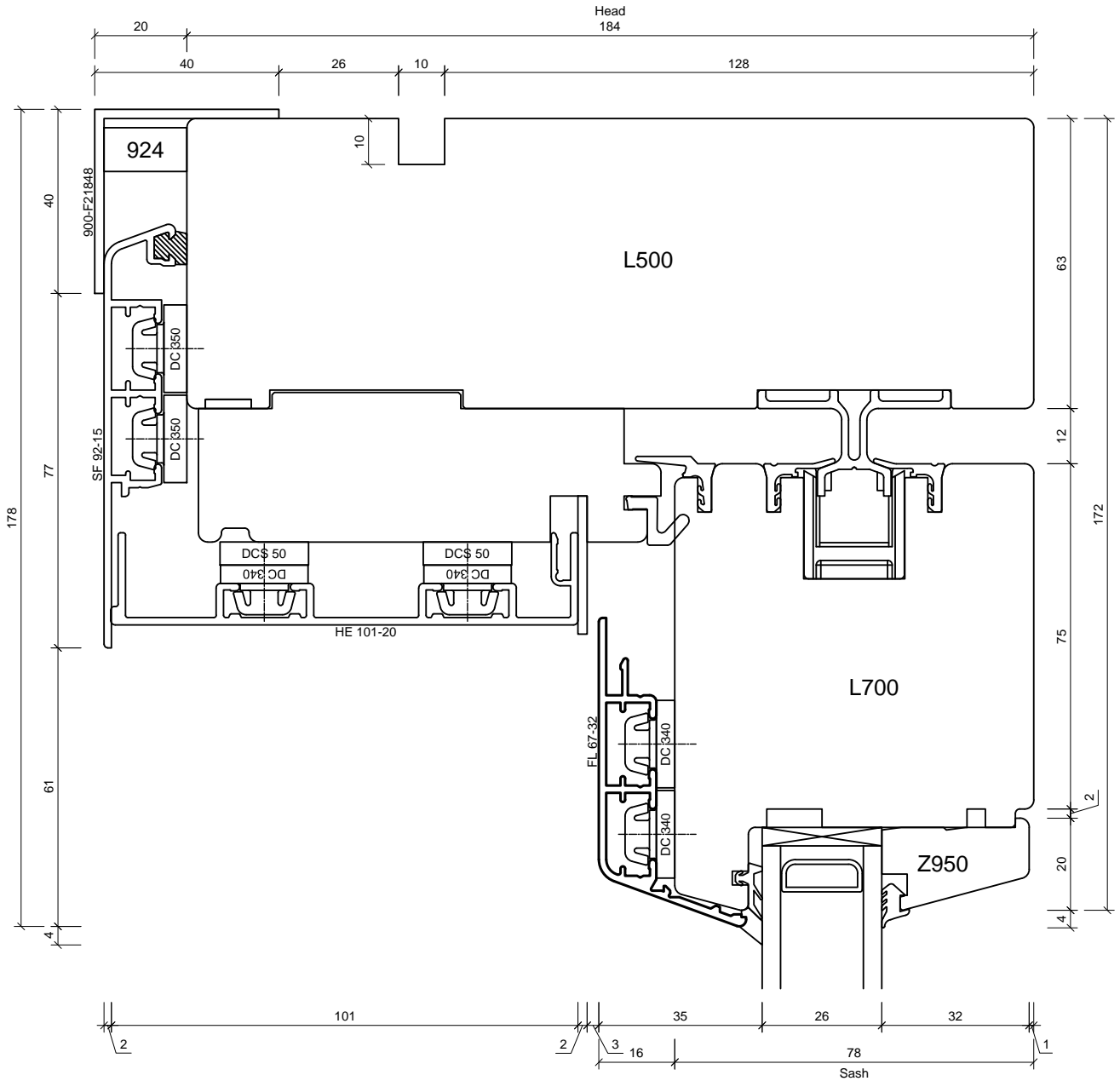
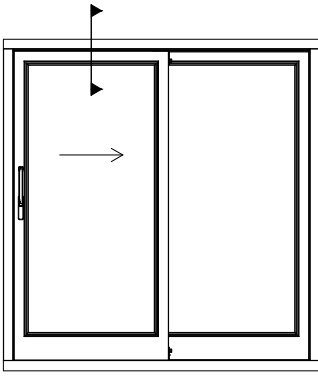

Studio 5
Old School Studios
140 Eastgate Street
Bury St Edmunds
Suffolk
IP33 1XX
Tel: 01284 705 468
sales@livingwoodwindows.co.uk
www.livingwoodwindows.co.uk

Drawing No.:
V-2ACLS104

Date:
06.09.11

Drawing Title:
2k Alu-Clad Lift & Slide Door
Section Through Head
Opening Screen

Drawn By:
JSE

Scale:
NTS

This drawing remains the property of Livingwood Windows Ltd and may not be reproduced without written permission. Livingwood Windows Ltd accepts no liability arising from any party acting on information contained within this drawing. It is advised that assistance is sought from Livingwood windows Ltd regarding matters of an individual project.

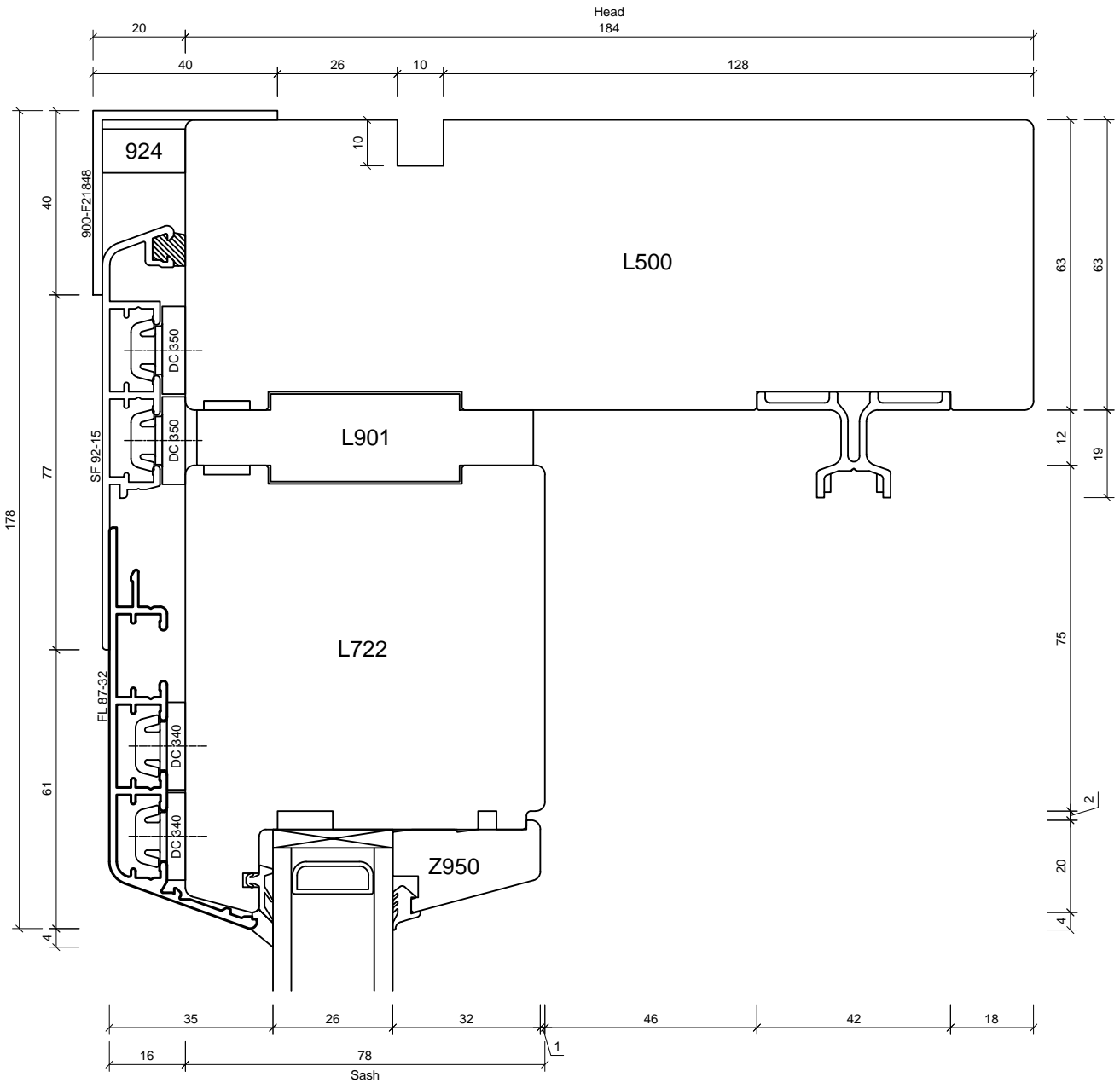
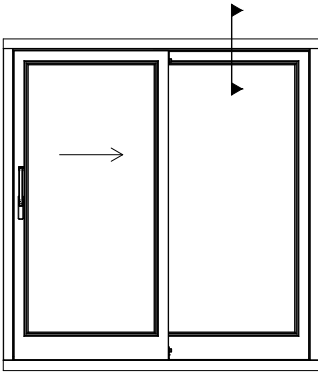

Studio 5
Old School Studios
140 Eastgate Street
Bury St Edmunds
Suffolk
IP33 1XX
Tel: 01284 705 468
sales@livingwoodwindows.co.uk
www.livingwoodwindows.co.uk

Drawing No.: V-2ACLS105	Date: 06.09.11
Drawing Title: 2k Alu-Clad Lift & Slide Door Section Through Head Fixed Screen	Drawn By: JSE
	Scale: NTS

This drawing remains the property of Livingwood Windows Ltd and may not be reproduced without written permission. Livingwood Windows Ltd accepts no liability arising from any party acting on information contained within this drawing. It is advised that assistance is sought from Livingwood windows Ltd regarding matters of an individual project.

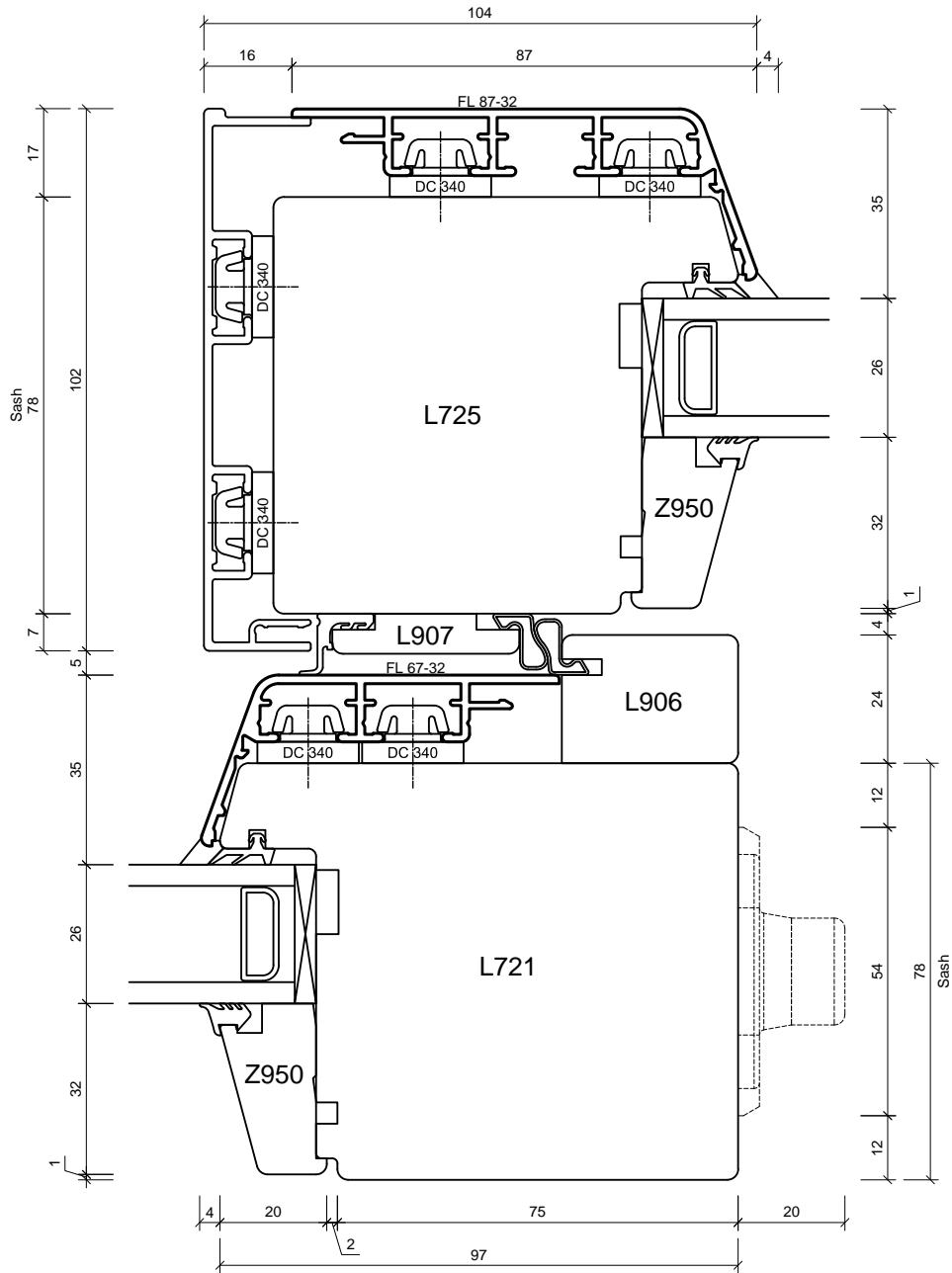
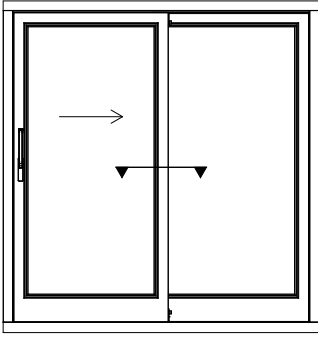

Studio 5
 Old School Studios
 140 Eastgate Street
 Bury St Edmunds
 Suffolk
 IP33 1XX
 Tel: 01284 705 468
 sales@livingwoodwindows.co.uk
 www.livingwoodwindows.co.uk

Drawing No.:	V-2ACLS106	Date:	06.09.11
Drawing Title:	2k Alu-Clad Lift & Slide Door Section Through Centre Opening Screen/Fixed Screen	Drawn By:	JSE
		Scale:	NTS
<small>This drawing remains the property of Livingwood Windows Ltd and may not be reproduced without written permission. Livingwood Windows Ltd accepts no liability arising from any party acting on information contained within this drawing. It is advised that assistance is sought from Livingwood windows Ltd regarding matters of an individual project.</small>			

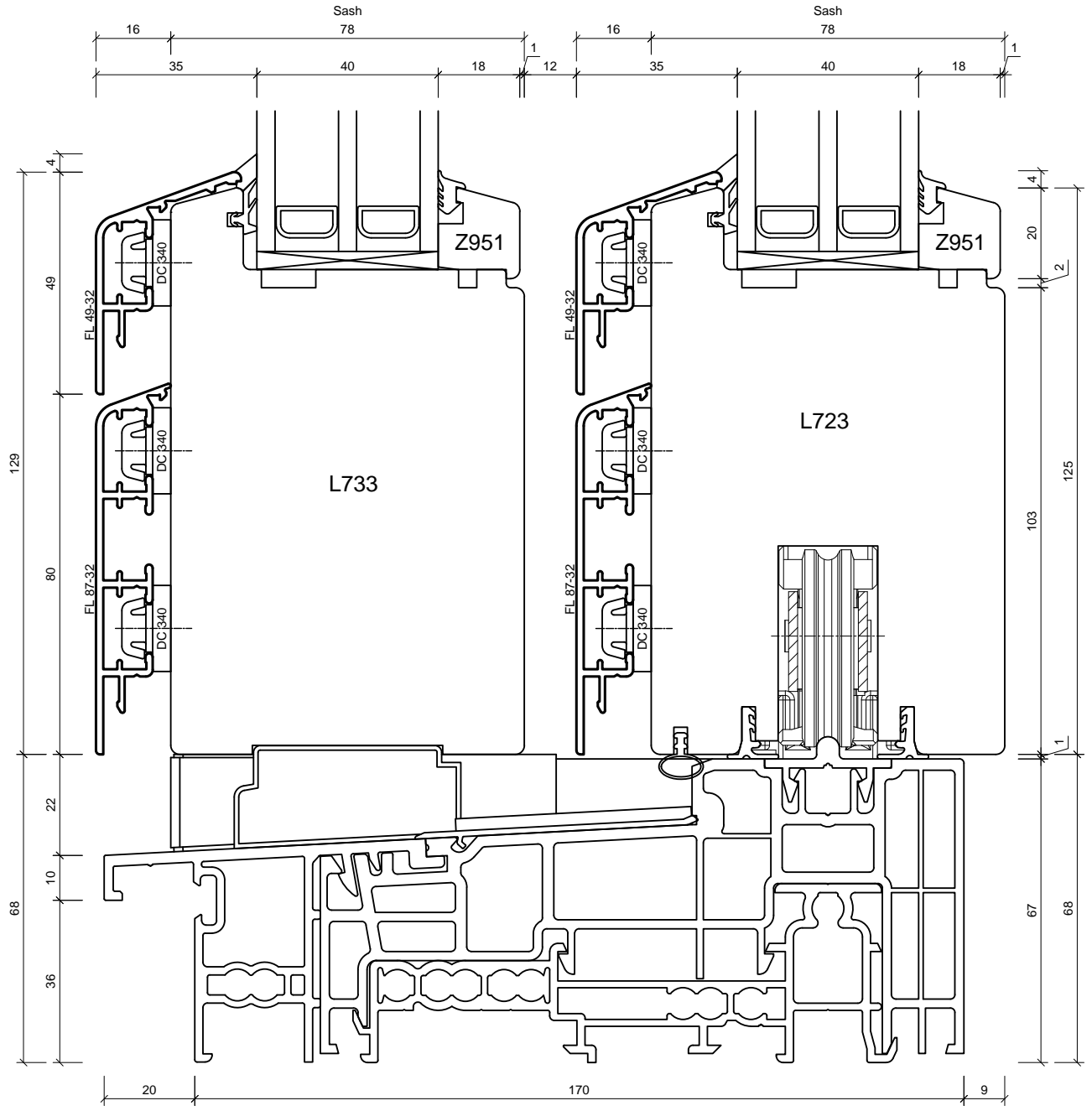
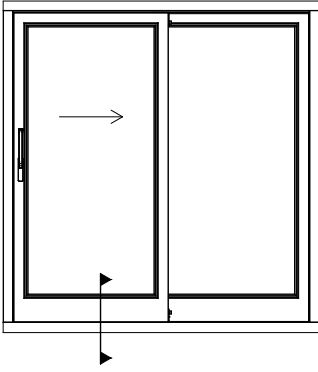

Studio 5
 Old School Studios
 140 Eastgate Street
 Bury St Edmunds
 Suffolk
 IP33 1XX
 Tel: 01284 705 468
 sales@livingwoodwindows.co.uk
 www.livingwoodwindows.co.uk

Drawing No.:	V-3ACLS101	Date:	06.09.11
Drawing Title:	3k Alu-Clad Lift & Slide Door Section Through Threshold Fixed Sceen/Opening Screen	Drawn By:	JSE
		Scale:	NTS
<small>This drawing remains the property of Livingwood Windows Ltd and may not be reproduced without written permission. Livingwood Windows Ltd accepts no liability arising from any party acting on information contained within this drawing. It is advised that assistance is sought from Livingwood windows Ltd regarding matters of an individual project.</small>			

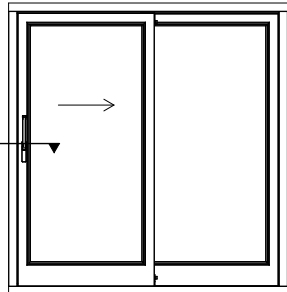
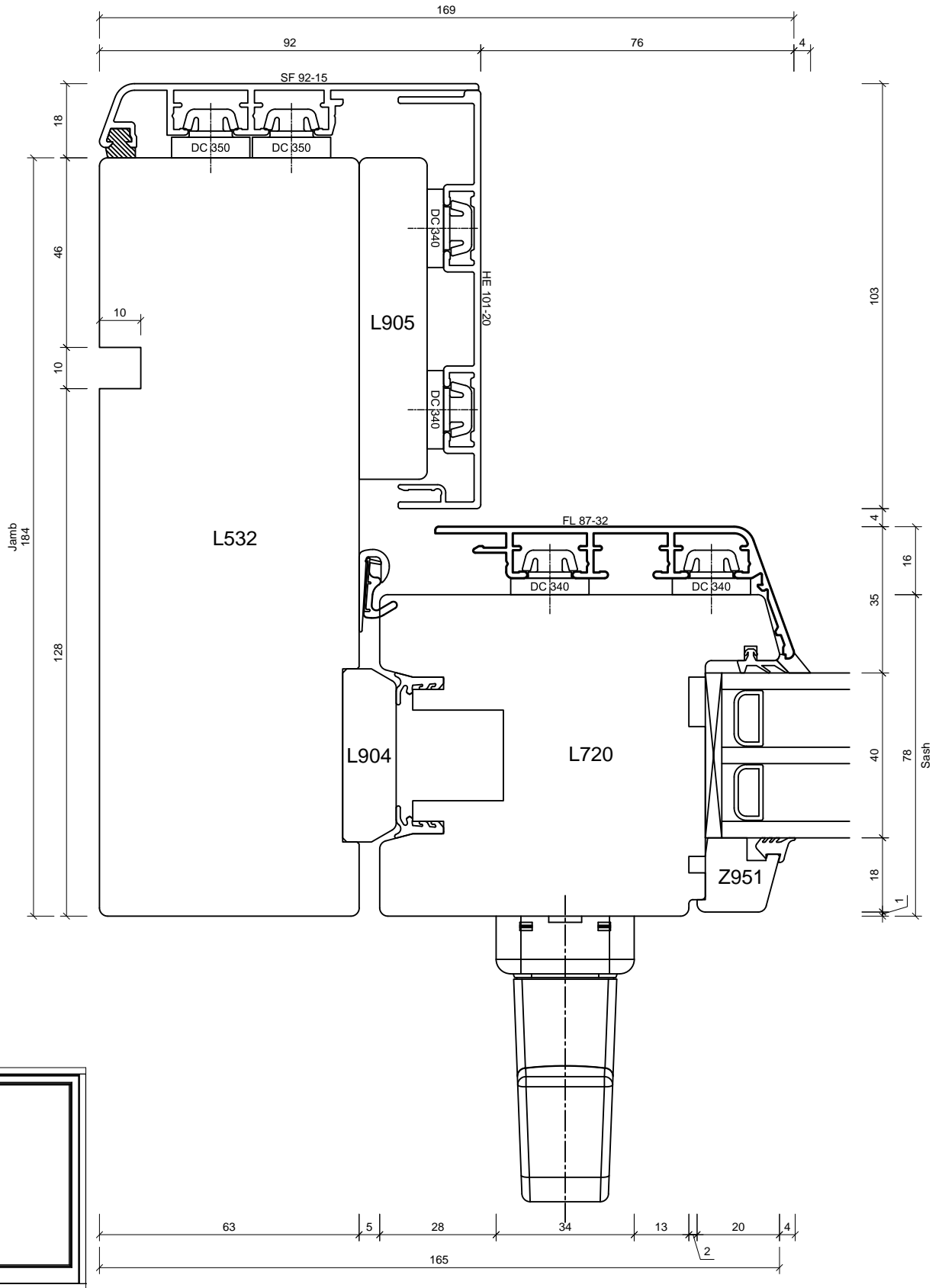

livingwood
 windows Ltd

Studio 5
 Old School Studios
 140 Eastgate Street
 Bury St Edmunds
 Suffolk
 IP33 1XX
 Tel: 01284 705 468
 sales@livingwoodwindows.co.uk
 www.livingwoodwindows.co.uk

Drawing No.:	V-3ACLS102	Date:	06.09.11
Drawing Title:	3k Alu-Clad Lift & Slide Door Section Through Jamb Opening Screen	Drawn By:	JSE
		Scale:	NTS
<small>This drawing remains the property of Livingwood Windows Ltd and may not be reproduced without written permission. Livingwood Windows Ltd accepts no liability arising from any party acting on information contained within this drawing. It is advised that assistance is sought from Livingwood windows Ltd regarding matters of an individual project.</small>			

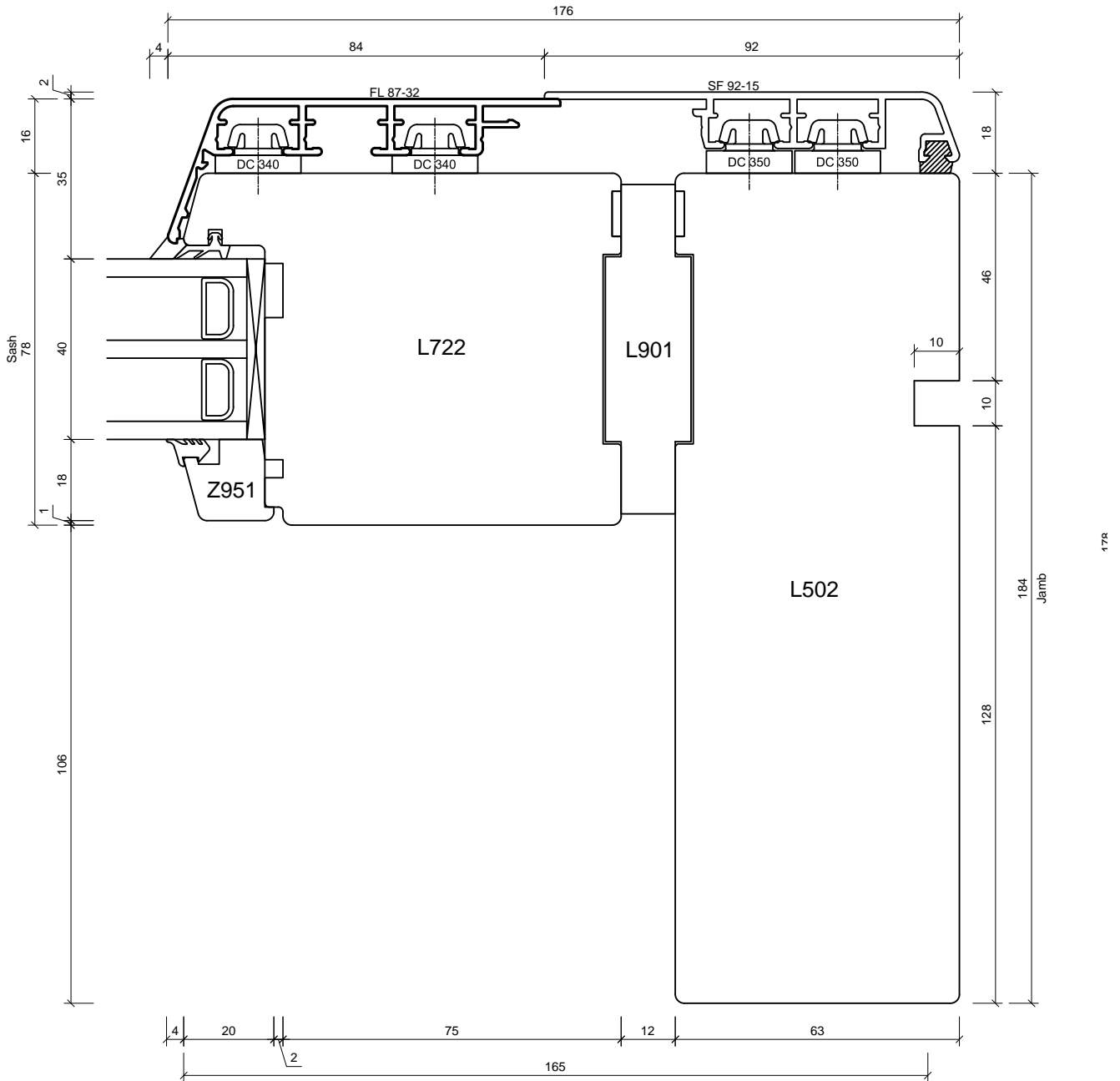
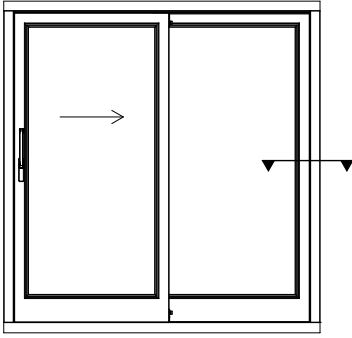

Studio 5
 Old School Studios
 140 Eastgate Street
 Bury St Edmunds
 Suffolk
 IP33 1XX
 Tel: 01284 705 468
 sales@livingwoodwindows.co.uk
 www.livingwoodwindows.co.uk

Drawing No.:	V-3ACLS103	Date:	06.09.11
Drawing Title:	3k Alu-Clad Lift & Slide Door Section Through Jamb Fixed Screen	Drawn By:	JSE
		Scale:	NTS

This drawing remains the property of Livingwood Windows Ltd and may not be reproduced without written permission. Livingwood Windows Ltd accepts no liability arising from any party acting on information contained within this drawing. It is advised that assistance is sought from Livingwood windows Ltd regarding matters of an individual project.

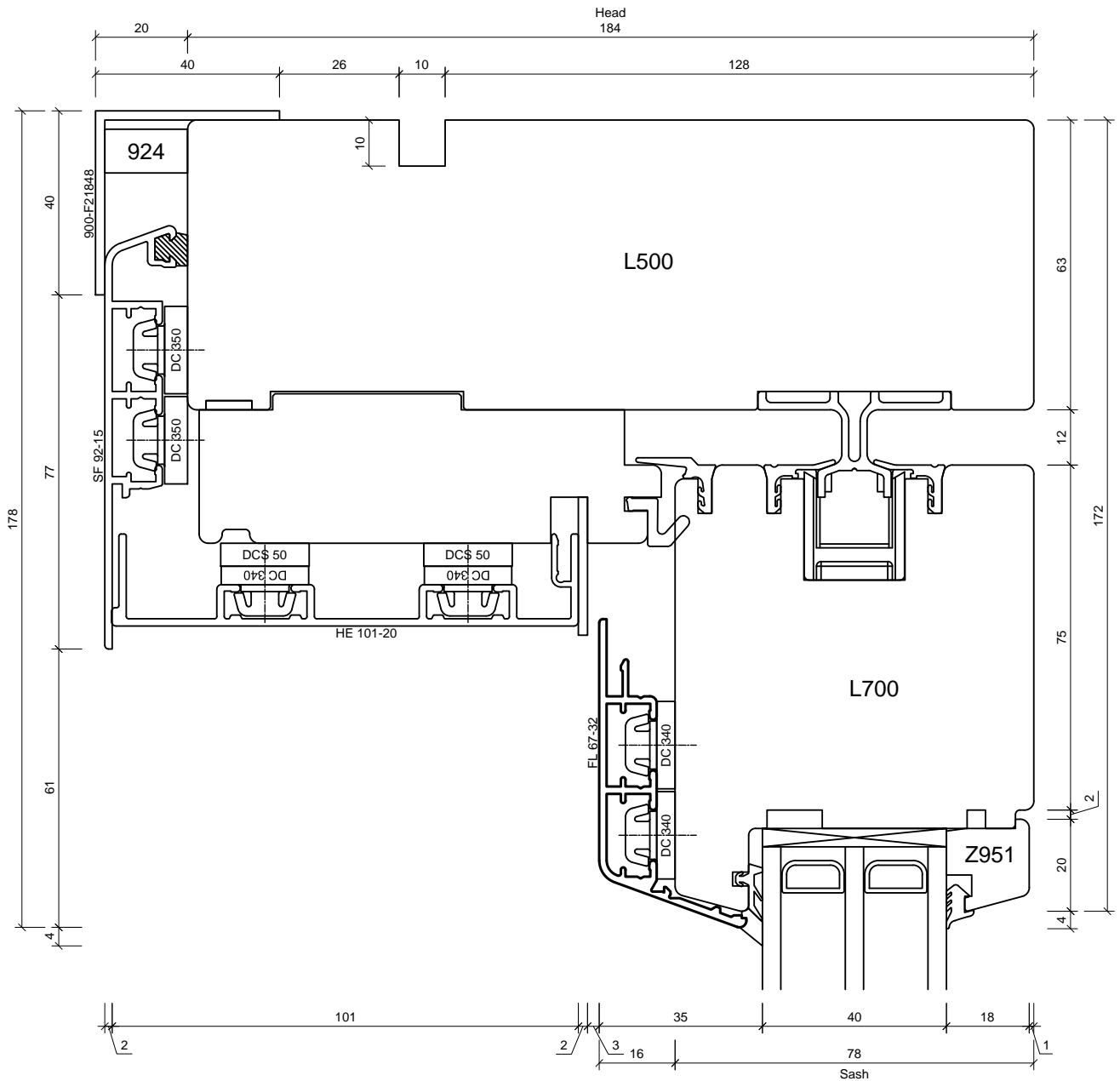
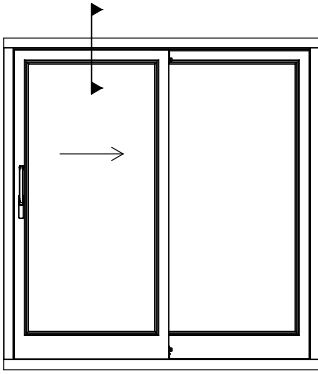

Studio 5
 Old School Studios
 140 Eastgate Street
 Bury St Edmunds
 Suffolk
 IP33 1XX
 Tel: 01284 705 468
 sales@livingwoodwindows.co.uk
 www.livingwoodwindows.co.uk

Drawing No.:	V-3ACLS104	Date:	06.09.11
Drawing Title:	3k Alu-Clad Lift & Slide Door Section Through Head Opening Screen	Drawn By:	JSE
		Scale:	NTS

This drawing remains the property of Livingwood Windows Ltd and may not be reproduced without written permission.
 Livingwood Windows Ltd accepts no liability arising from any party acting on information contained within this drawing.
 It is advised that assistance is sought from Livingwood windows Ltd regarding matters of an individual project.

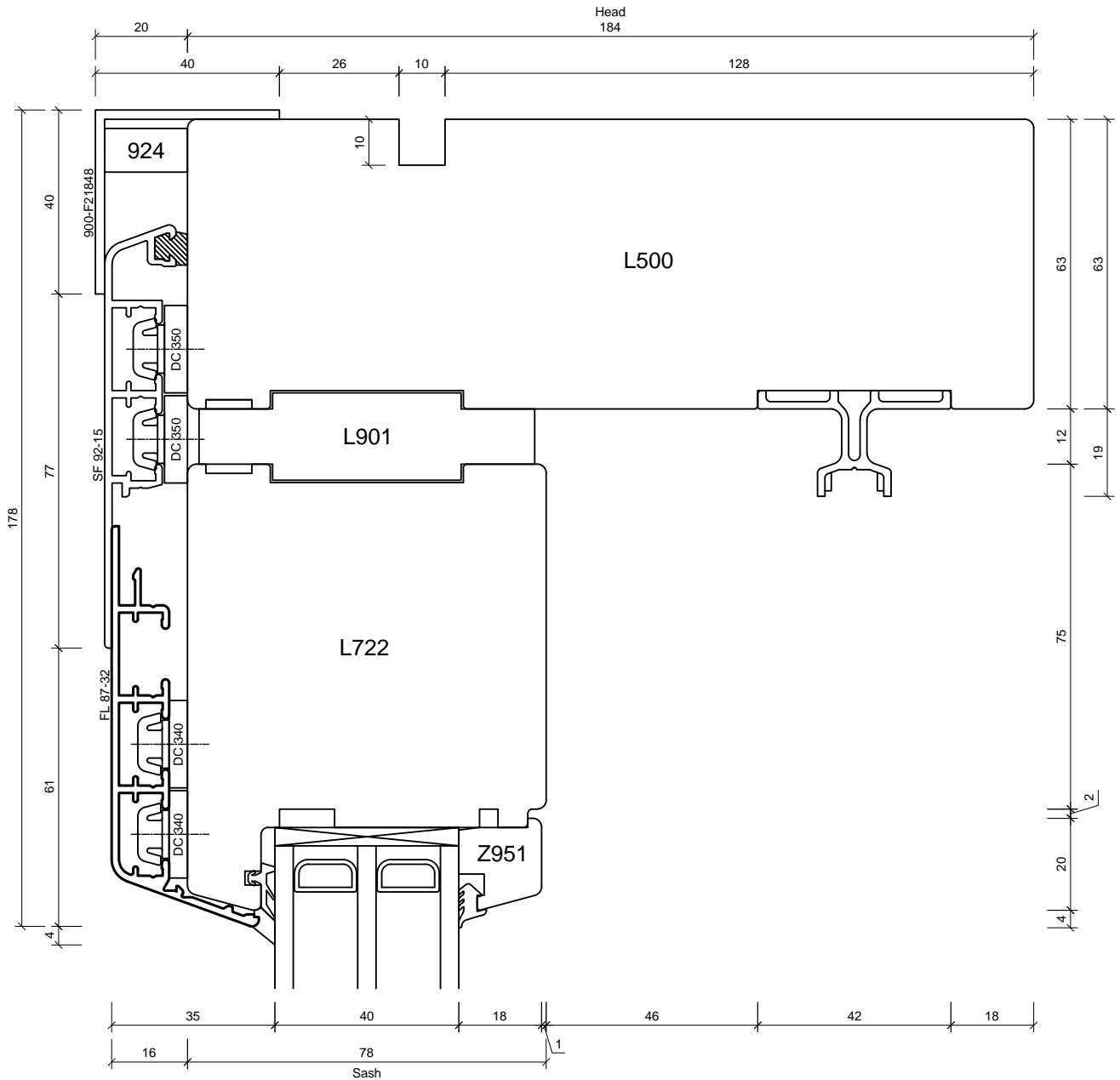
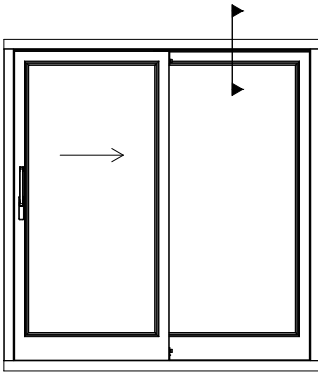

Studio 5
 Old School Studios
 140 Eastgate Street
 Bury St Edmunds
 Suffolk
 IP33 1XX
 Tel: 01284 705 468
 sales@livingwoodwindows.co.uk
 www.livingwoodwindows.co.uk

Drawing No.: V-3ACLS105	Date: 06.09.11
Drawing Title: 3k Alu-Clad Lift & Slide Door Section Through Head Fixed Screen	Drawn By: JSE
	Scale: NTS

This drawing remains the property of Livingwood Windows Ltd and may not be reproduced without written permission.
 Livingwood Windows Ltd accepts no liability arising from any party acting on information contained within this drawing.
 It is advised that assistance is sought from Livingwood windows Ltd regarding matters of an individual project.

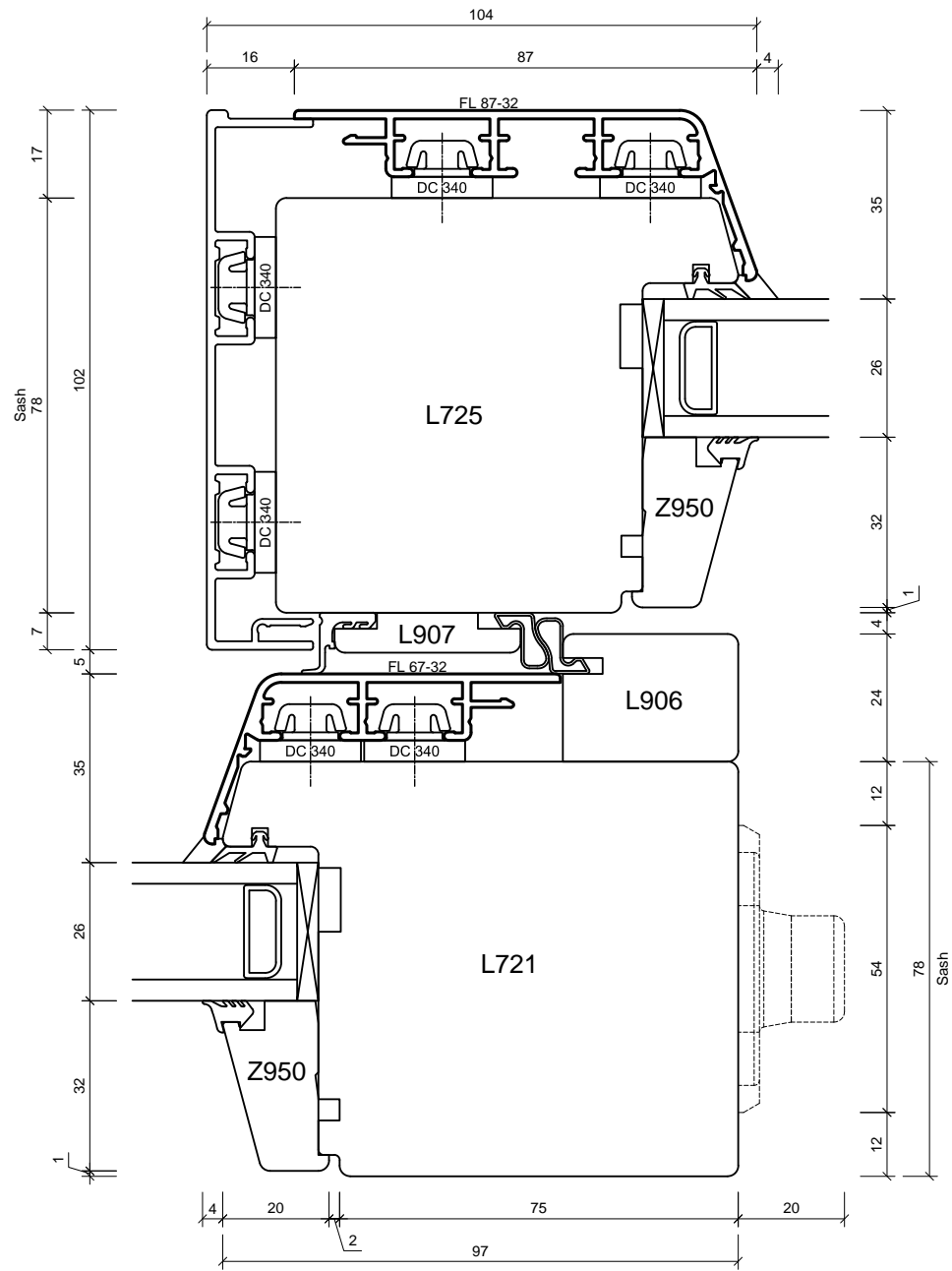
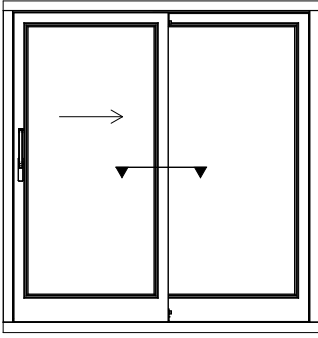

Studio 5
 Old School Studios
 140 Eastgate Street
 Bury St Edmunds
 Suffolk
 IP33 1XX
 Tel: 01284 705 468
 sales@livingwoodwindows.co.uk
 www.livingwoodwindows.co.uk

Drawing No.: V-3ACLS106	Date: 06.09.11
Drawing Title: 3k Alu-Clad Lift & Slide Door Section Through Centre Opening Screen/Fixed Screen	Drawn By: JSE
	Scale: NTS
<small>This drawing remains the property of Livingwood Windows Ltd and may not be reproduced without written permission. Livingwood Windows Ltd accepts no liability arising from any party acting on information contained within this drawing. It is advised that assistance is sought from Livingwood windows Ltd regarding matters of an individual project.</small>	