

Studio 5  
Old School Studios  
140 Eastgate Street  
Bury St Edmunds  
Suffolk  
IP33 1XX  
Tel: 01284 705 468  
sales@livingwoodwindows.co.uk  
www.livingwoodwindows.co.uk

Drawing No.:	S-TH88TT101	Date:	06.09.11
Drawing Title:	Thermo 88 Tilt & Turn Window Section Through Sill Opening Sash	Drawn By:	JSE
		Scale:	NTS

This drawing remains the property of Livingwood Windows Ltd and may not be reproduced without written permission. Livingwood Windows Ltd accepts no liability arising from any party acting on information contained within this drawing. It is advised that assistance is sought from Livingwood windows Ltd regarding matters of an individual project.

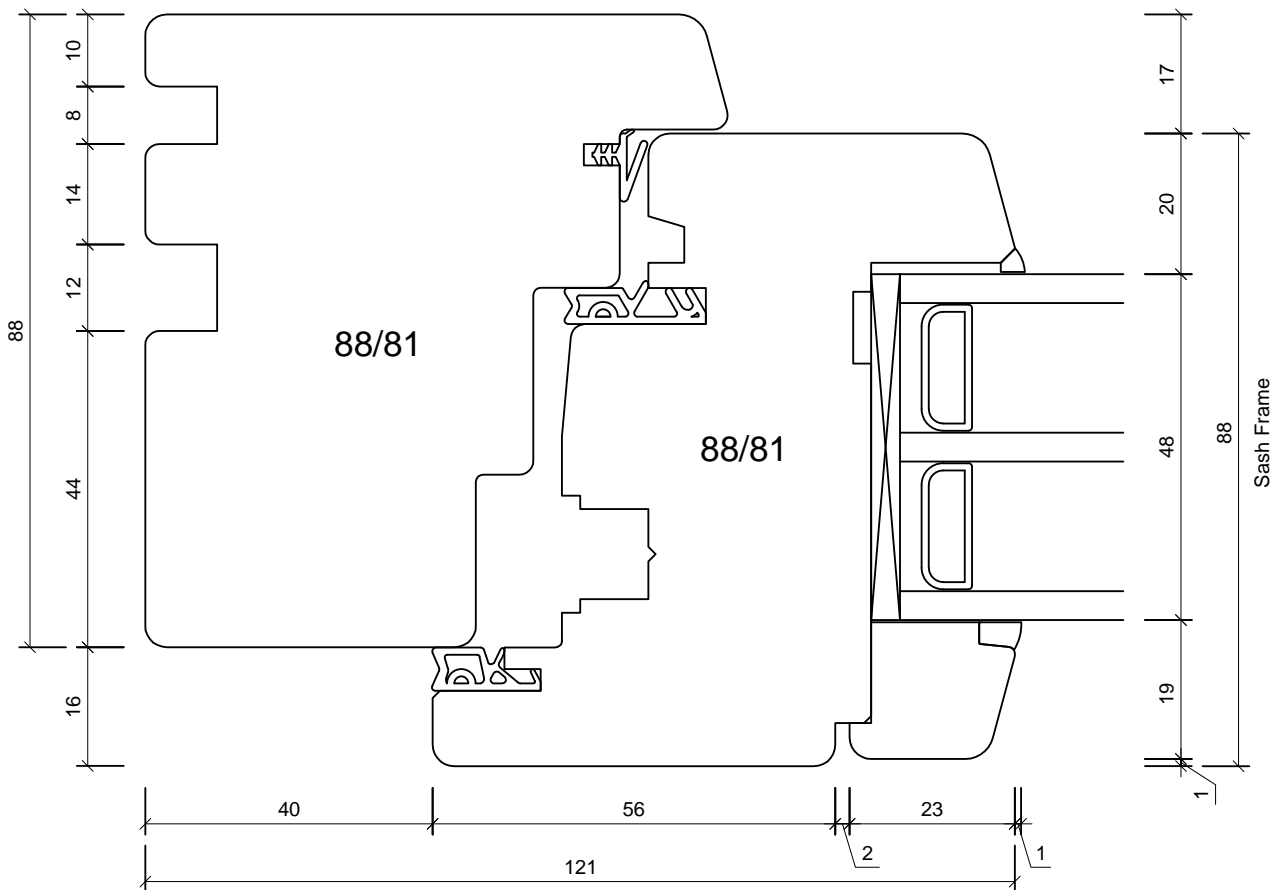
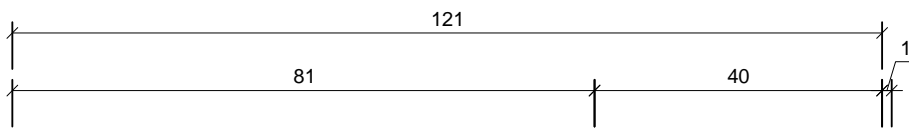
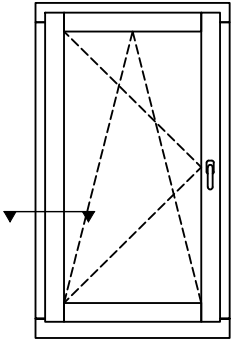

Studio 5  
 Old School Studios  
 140 Eastgate Street  
 Bury St Edmunds  
 Suffolk  
 IP33 1XX  
 Tel: 01284 705 468  
 sales@livingwoodwindows.co.uk  
 www.livingwoodwindows.co.uk

Drawing No.:	S-TH88TT102	Date:	06.09.11
Drawing Title:	Thermo 88 Tilt & Turn Window Section Through Jamb Opening Sash	Drawn By:	JSE
		Scale:	NTS
<small>This drawing remains the property of Livingwood Windows Ltd and may not be reproduced without written permission. Livingwood Windows Ltd accepts no liability arising from any party acting on information contained within this drawing. It is advised that assistance is sought from Livingwood windows Ltd regarding matters of an individual project.</small>			

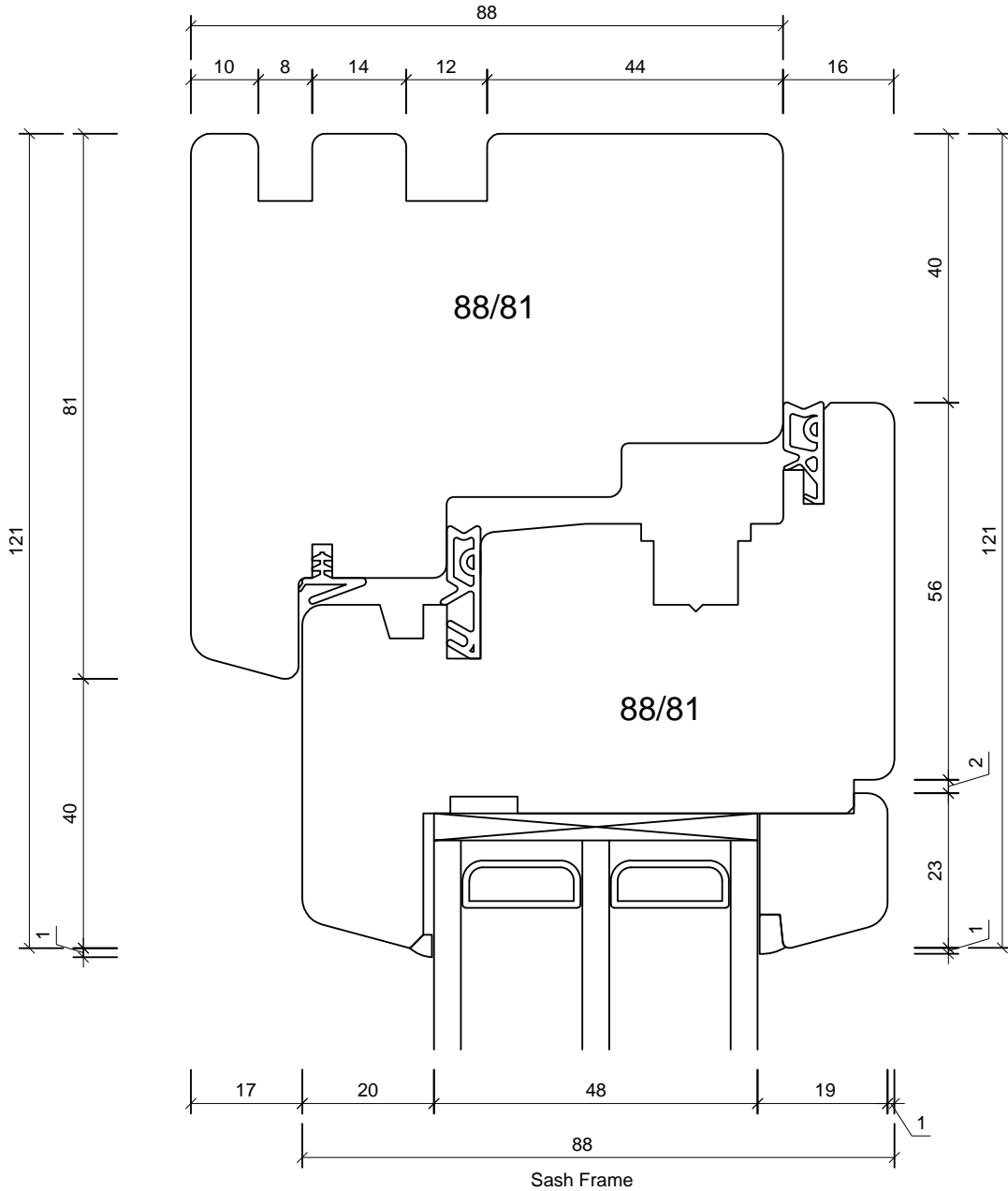
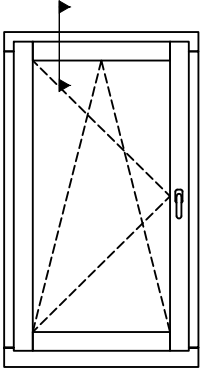

Studio 5  
 Old School Studios  
 140 Eastgate Street  
 Bury St Edmunds  
 Suffolk  
 IP33 1XX  
 Tel: 01284 705 468  
 sales@livingwoodwindows.co.uk  
 www.livingwoodwindows.co.uk

Drawing No.:	S-TH88TT103	Date:	06.09.11
Drawing Title:	Thermo 88 Tilt & Turn Window Section Through Head Opening Sash	Drawn By:	JSE
		Scale:	NTS

This drawing remains the property of Livingwood Windows Ltd and may not be reproduced without written permission.  
 Livingwood Windows Ltd accepts no liability arising from any party acting on information contained within this drawing.  
 It is advised that assistance is sought from Livingwood windows Ltd regarding matters of an individual project.

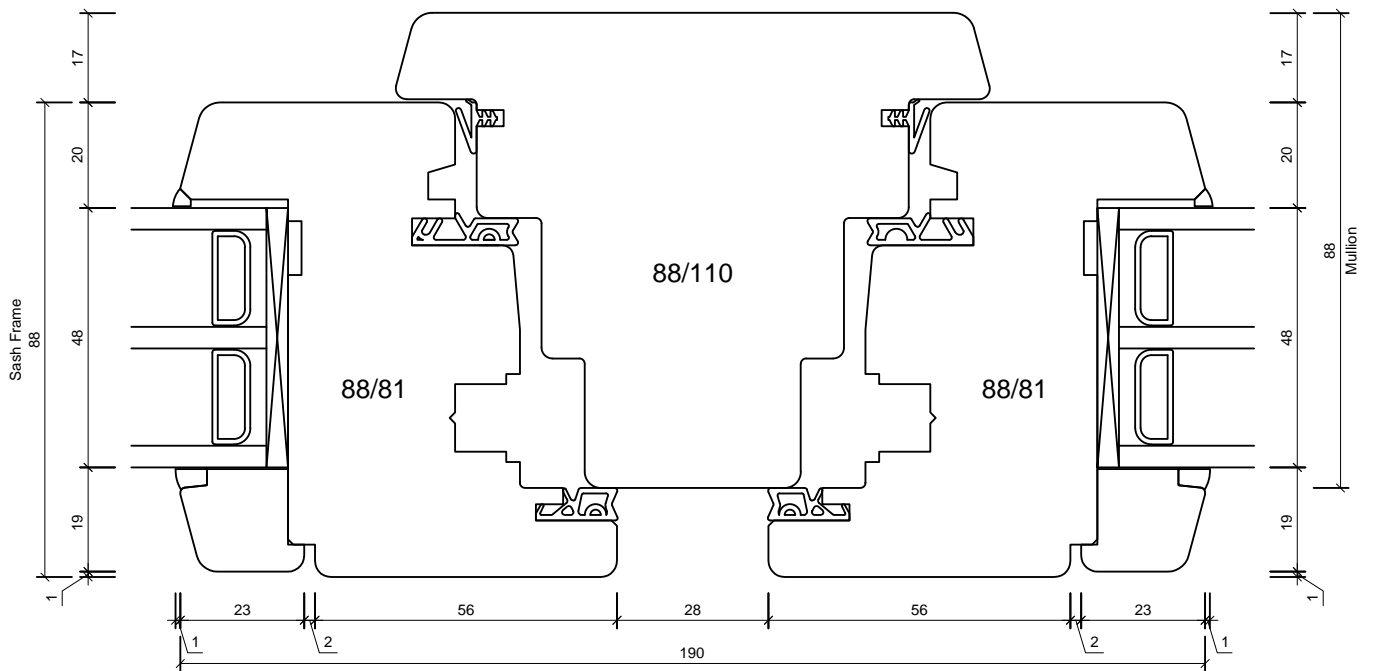
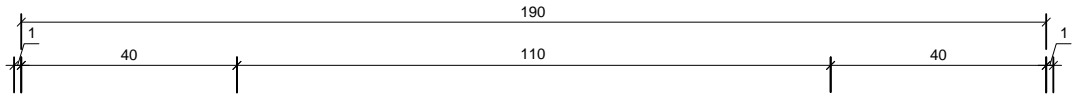
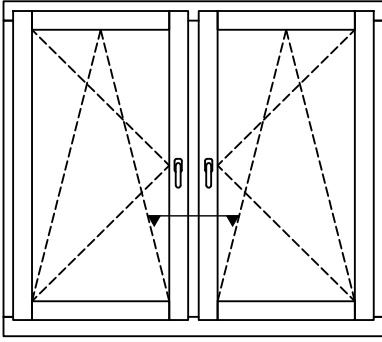

Studio 5  
 Old School Studios  
 140 Eastgate Street  
 Bury St Edmunds  
 Suffolk  
 IP33 1XX  
 Tel: 01284 705 468  
 sales@livingwoodwindows.co.uk  
 www.livingwoodwindows.co.uk

Drawing No.:	S-TH88TT104	Date:	06.09.11
Drawing Title:	Thermo 88 Tilt & Turn Window Section Through Mullion Opening Sash/Opening Sash	Drawn By:	JSE
		Scale:	NTS

This drawing remains the property of Livingwood Windows Ltd and may not be reproduced without written permission.  
 Livingwood Windows Ltd accepts no liability arising from any party acting on information contained within this drawing.  
 It is advised that assistance is sought from Livingwood windows Ltd regarding matters of an individual project.

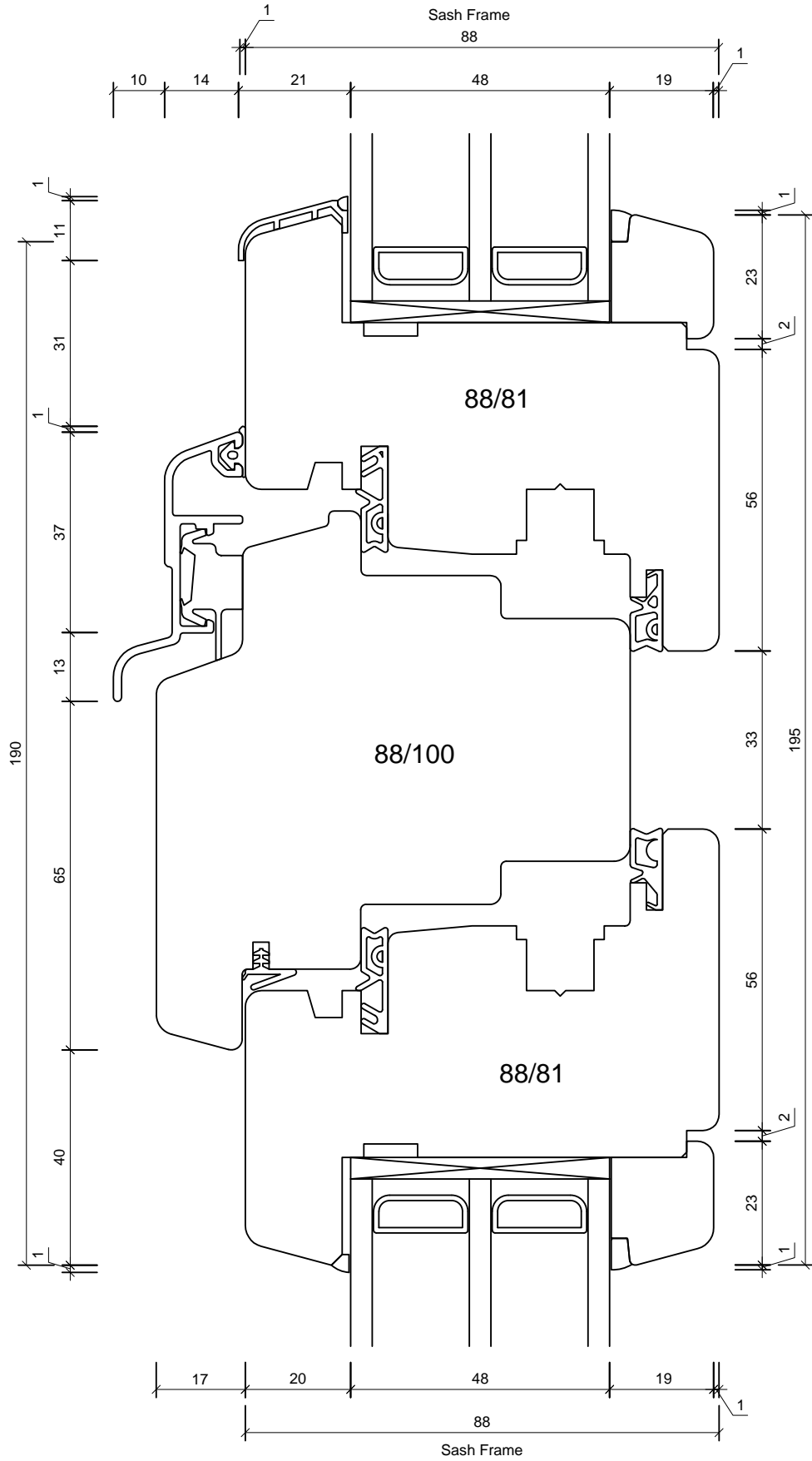
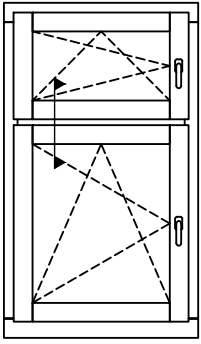

Studio 5  
 Old School Studios  
 140 Eastgate Street  
 Bury St Edmunds  
 Suffolk  
 IP33 1XX  
 Tel: 01284 705 468  
 sales@livingwoodwindows.co.uk  
 www.livingwoodwindows.co.uk

Drawing No.:	S-TH88TT105	Date:	06.09.11
Drawing Title:	Thermo 88 Tilt & Turn Window Section Through Transom Opening Sash/Opening Sash	Drawn By:	JSE
		Scale:	NTS

This drawing remains the property of Livingwood Windows Ltd and may not be reproduced without written permission.  
 Livingwood Windows Ltd accepts no liability arising from any party acting on information contained within this drawing.  
 It is advised that assistance is sought from Livingwood windows Ltd regarding matters of an individual project.

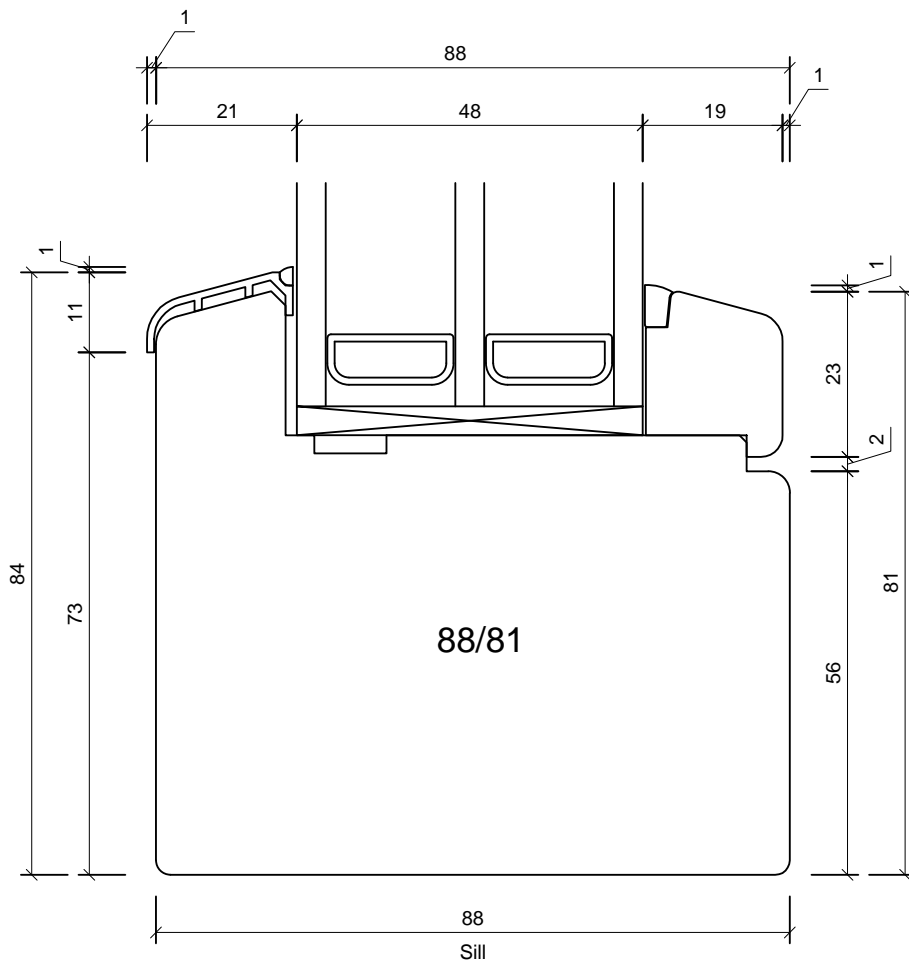
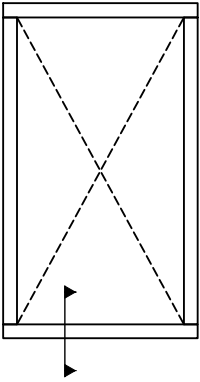

Studio 5  
 Old School Studios  
 140 Eastgate Street  
 Bury St Edmunds  
 Suffolk  
 IP33 1XX  
 Tel: 01284 705 468  
 sales@livingwoodwindows.co.uk  
 www.livingwoodwindows.co.uk

Drawing No.: S-TH88TT106	Date: 06.09.11
Drawing Title: Thermo 88 Tilt & Turn Window Section Through Sill Fixed Light	Drawn By: JSE
	Scale: NTS

This drawing remains the property of Livingwood Windows Ltd and may not be reproduced without written permission. Livingwood Windows Ltd accepts no liability arising from any party acting on information contained within this drawing. It is advised that assistance is sought from Livingwood windows Ltd regarding matters of an individual project.

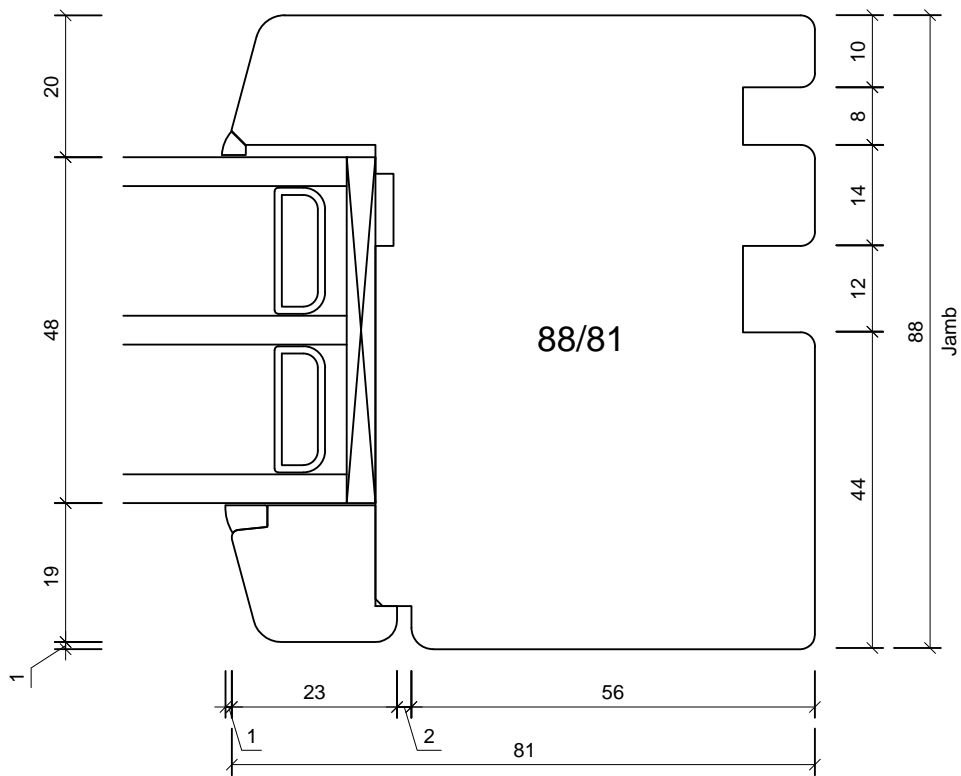
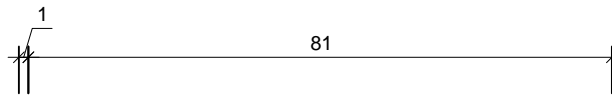
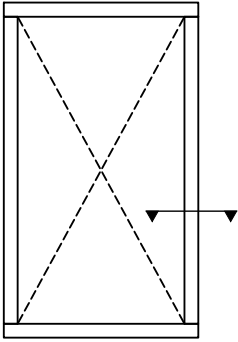

Studio 5  
 Old School Studios  
 140 Eastgate Street  
 Bury St Edmunds  
 Suffolk  
 IP33 1XX  
 Tel: 01284 705 468  
 sales@livingwoodwindows.co.uk  
 www.livingwoodwindows.co.uk

Drawing No.:	S-TH88TT107	Date:	06.09.11
Drawing Title:	Thermo 88 Tilt & Turn Window Section Through Jamb Fixed Light	Drawn By:	JSE
		Scale:	NTS
<small>This drawing remains the property of Livingwood Windows Ltd and may not be reproduced without written permission. Livingwood Windows Ltd accepts no liability arising from any party acting on information contained within this drawing. It is advised that assistance is sought from Livingwood windows Ltd regarding matters of an individual project.</small>			

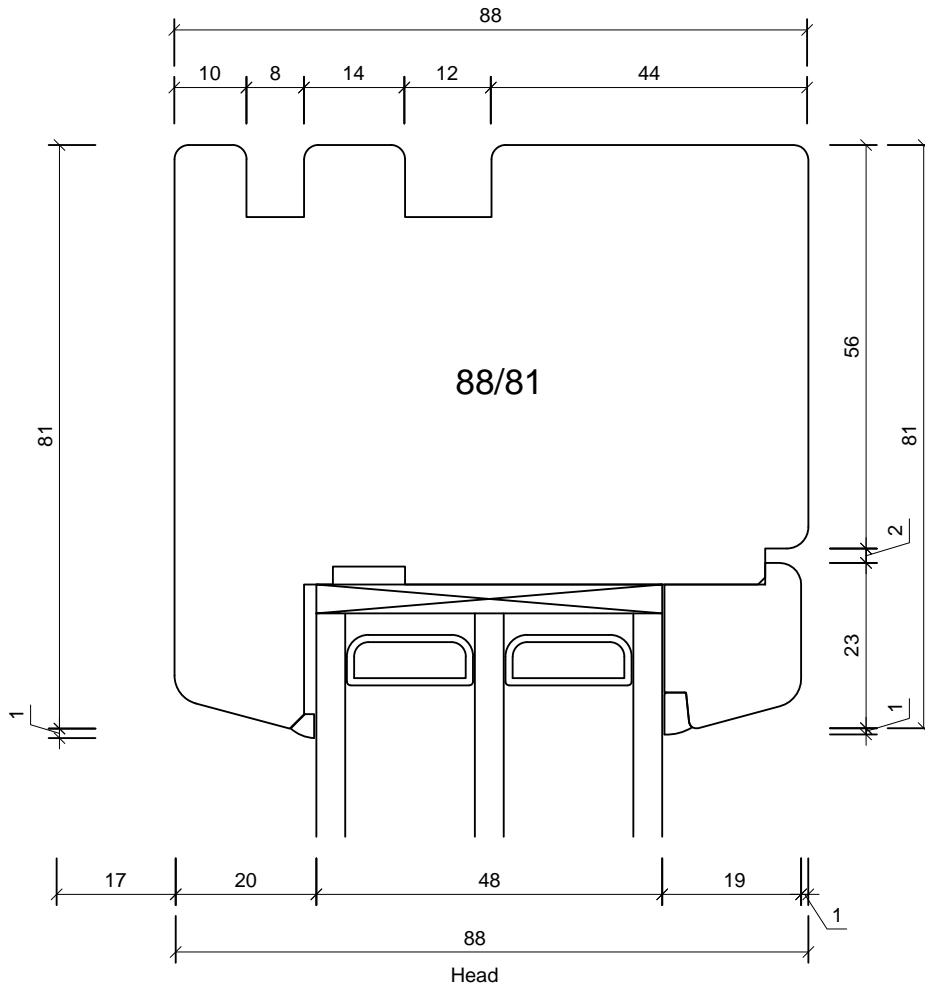
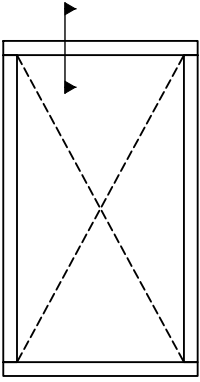

Studio 5  
 Old School Studios  
 140 Eastgate Street  
 Bury St Edmunds  
 Suffolk  
 IP33 1XX  
 Tel: 01284 705 468  
 sales@livingwoodwindows.co.uk  
 www.livingwoodwindows.co.uk

Drawing No.:	S-TH88TT108	Date:	06.09.11
Drawing Title:	Thermo 88 Tilt & Turn Window Section Through Head Fixed Light	Drawn By:	JSE
		Scale:	NTS
<small>This drawing remains the property of Livingwood Windows Ltd and may not be reproduced without written permission. Livingwood Windows Ltd accepts no liability arising from any party acting on information contained within this drawing. It is advised that assistance is sought from Livingwood windows Ltd regarding matters of an individual project.</small>			

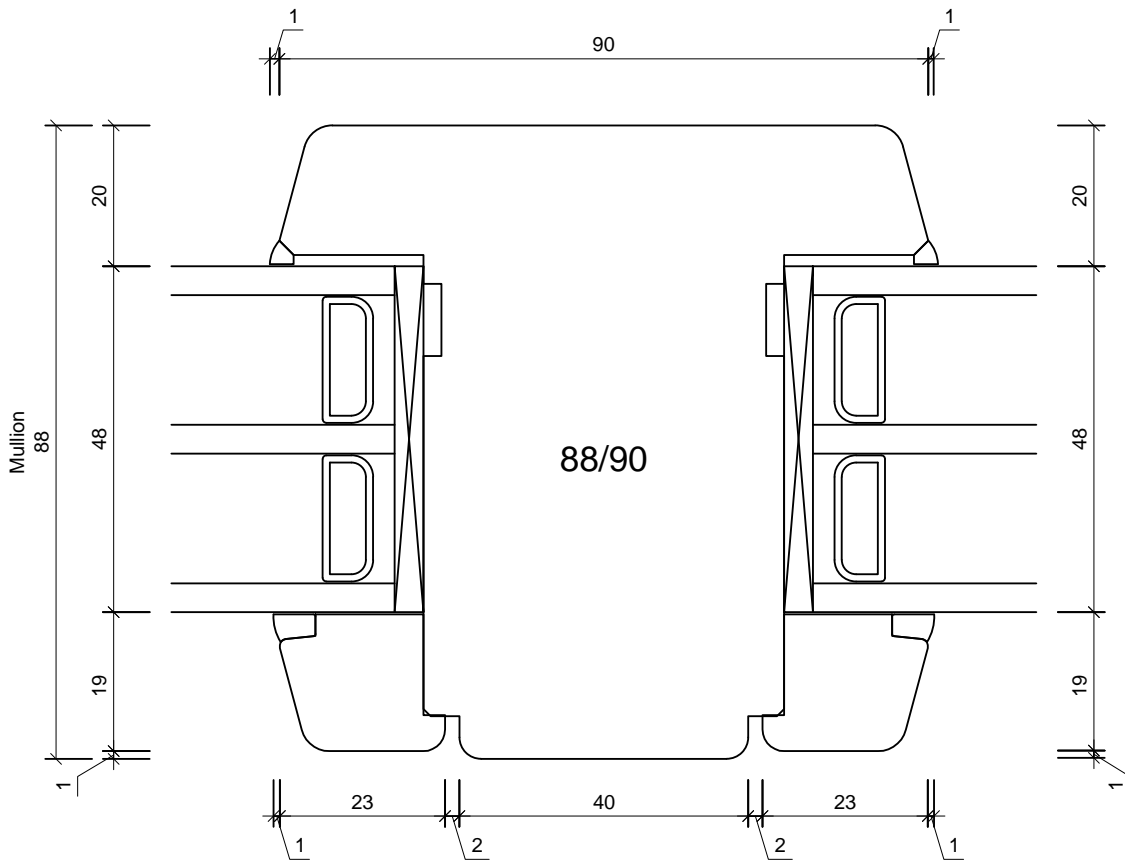
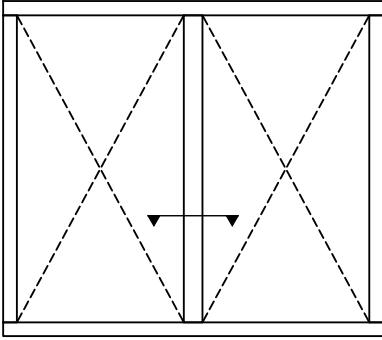

Studio 5  
 Old School Studios  
 140 Eastgate Street  
 Bury St Edmunds  
 Suffolk  
 IP33 1XX  
 Tel: 01284 705 468  
 sales@livingwoodwindows.co.uk  
 www.livingwoodwindows.co.uk

Drawing No.:	S-TH88TT109	Date:	06.09.11
Drawing Title:	Thermo 88 Tilt & Turn Window Section Through Mullion Fixed Light/Fixed Light	Drawn By:	JSE
		Scale:	NTS
<small>This drawing remains the property of Livingwood Windows Ltd and may not be reproduced without written permission. Livingwood Windows Ltd accepts no liability arising from any party acting on information contained within this drawing. It is advised that assistance is sought from Livingwood windows Ltd regarding matters of an individual project.</small>			

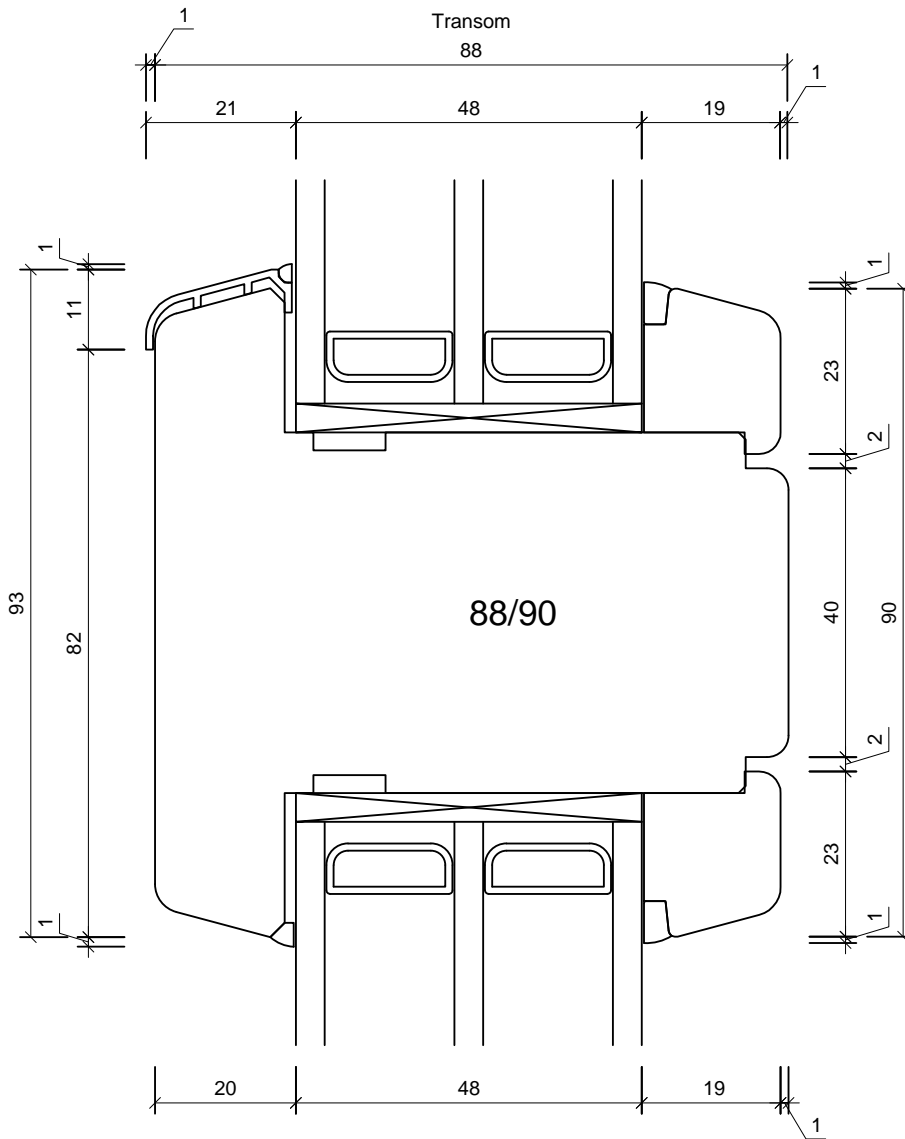
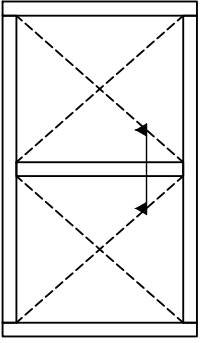

Studio 5  
 Old School Studios  
 140 Eastgate Street  
 Bury St Edmunds  
 Suffolk  
 IP33 1XX  
 Tel: 01284 705 468  
 sales@livingwoodwindows.co.uk  
 www.livingwoodwindows.co.uk

Drawing No.:	S-TH88TT110	Date:	06.09.11
Drawing Title:	Thermo 88 Tilt & Turn Window Section Through Transom Fixed Light/Fixed Light	Drawn By:	JSE
		Scale:	NTS
<small>This drawing remains the property of Livingwood Windows Ltd and may not be reproduced without written permission. Livingwood Windows Ltd accepts no liability arising from any party acting on information contained within this drawing. It is advised that assistance is sought from Livingwood windows Ltd regarding matters of an individual project.</small>			

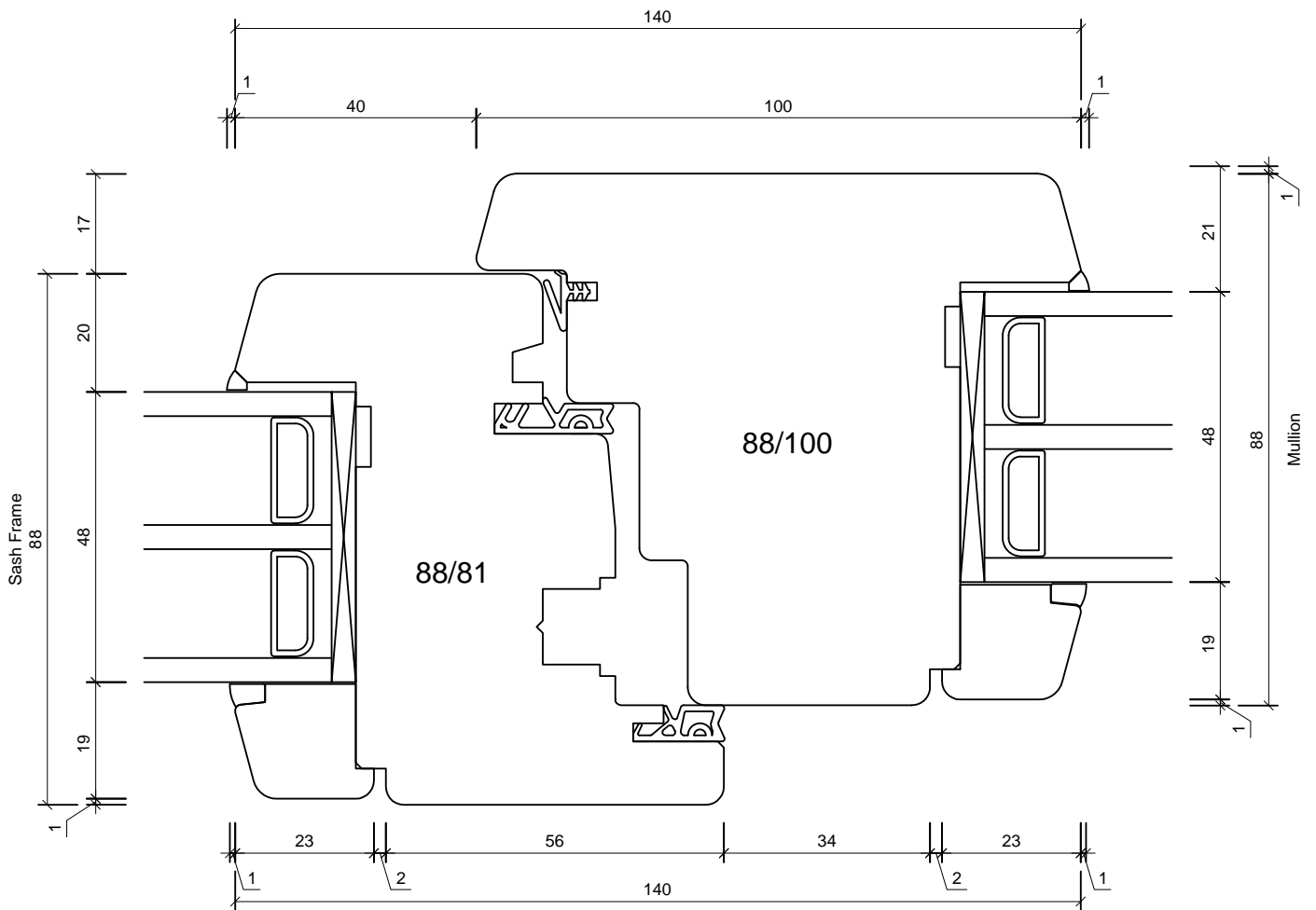
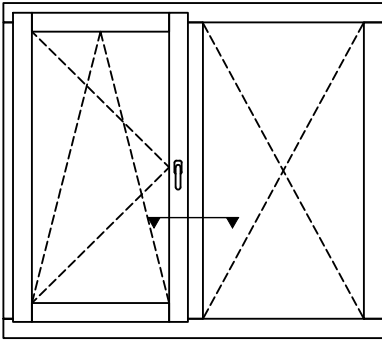

Studio 5  
 Old School Studios  
 140 Eastgate Street  
 Bury St Edmunds  
 Suffolk  
 IP33 1XX  
 Tel: 01284 705 468  
 sales@livingwoodwindows.co.uk  
 www.livingwoodwindows.co.uk

Drawing No.:	S-TH88TT111	Date:	06.09.11
Drawing Title:	Thermo 88 Tilt & Turn Window Section Through Mullion Opening Sash/Fixed Light	Drawn By:	JSE
		Scale:	NTS

This drawing remains the property of Livingwood Windows Ltd and may not be reproduced without written permission.  
 Livingwood Windows Ltd accepts no liability arising from any party acting on information contained within this drawing.  
 It is advised that assistance is sought from Livingwood windows Ltd regarding matters of an individual project.

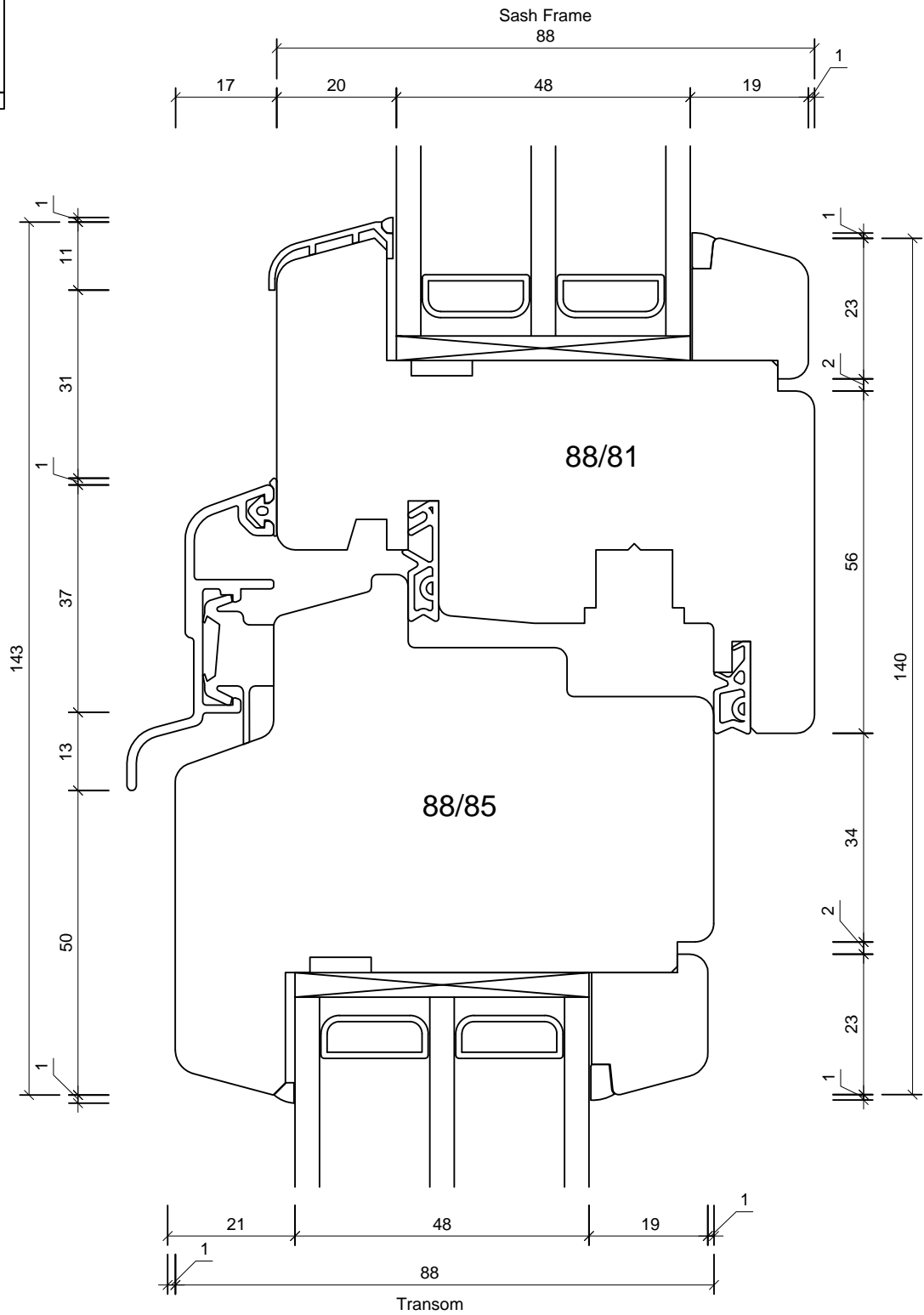
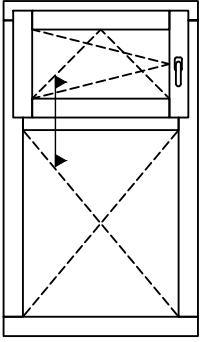

Studio 5  
 Old School Studios  
 140 Eastgate Street  
 Bury St Edmunds  
 Suffolk  
 IP33 1XX  
 Tel: 01284 705 468  
 sales@livingwoodwindows.co.uk  
 www.livingwoodwindows.co.uk

Drawing No.: S-TH88TT112	Date: 06.09.11
Drawing Title: Thermo 88 Tilt & Turn Window Section Through Transom Opening Sash Over Fixed Light	Drawn By: JSE
	Scale: NTS

This drawing remains the property of Livingwood Windows Ltd and may not be reproduced without written permission. Livingwood Windows Ltd accepts no liability arising from any party acting on information contained within this drawing. It is advised that assistance is sought from Livingwood windows Ltd regarding matters of an individual project.

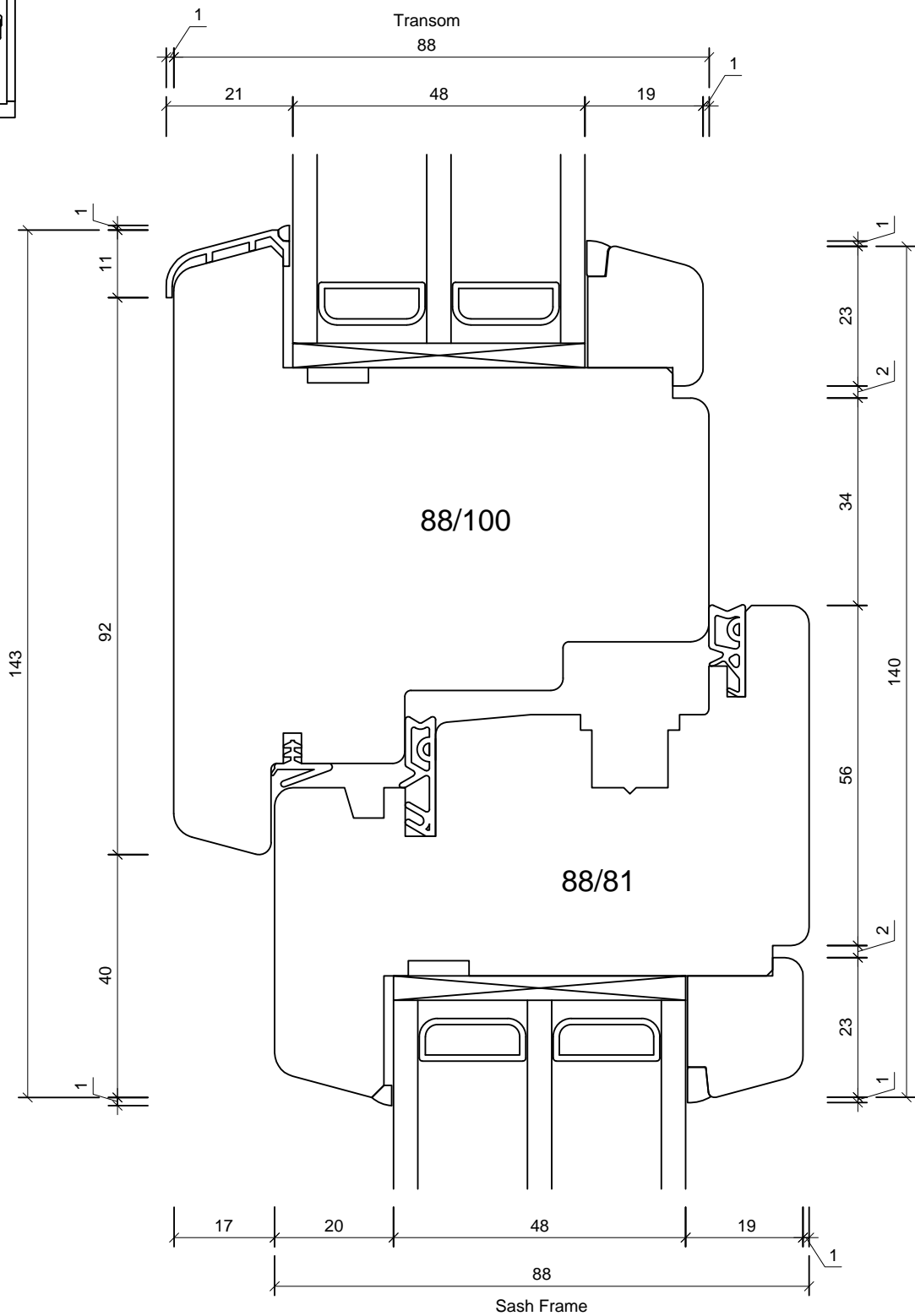
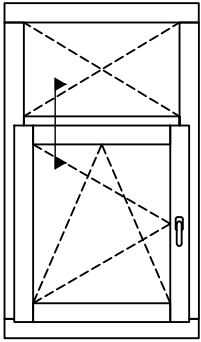

Studio 5  
Old School Studios  
140 Eastgate Street  
Bury St Edmunds  
Suffolk  
IP33 1XX  
Tel: 01284 705 468  
sales@livingwoodwindows.co.uk  
www.livingwoodwindows.co.uk

Drawing No.:	S-TH88TT113	Date:	06.09.11
Drawing Title:	Thermo 88 Tilt & Turn Window Section Through Transom Fixed Light Over Opening Sash	Drawn By:	JSE
		Scale:	NTS
<small>This drawing remains the property of Livingwood Windows Ltd and may not be reproduced without written permission. Livingwood Windows Ltd accepts no liability arising from any party acting on information contained within this drawing. It is advised that assistance is sought from Livingwood windows Ltd regarding matters of an individual project.</small>			