

Studio 5 Old School Studios
 140 Eastgate Street
 Bury St Edmunds, Suffolk
 IP33 1XX
 phone: 01284 705 468
 www.livingwoodwindows.co.uk
 sales@livingwoodwindows.co.uk

Livingwood Windows Limited	
Lift and Slide door 2k Section through head, leaf and threshold double track	
DATE	14/06/2010
SCALE	do not scale

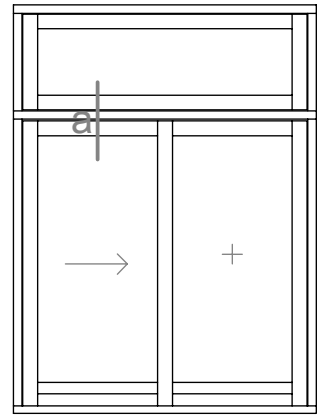
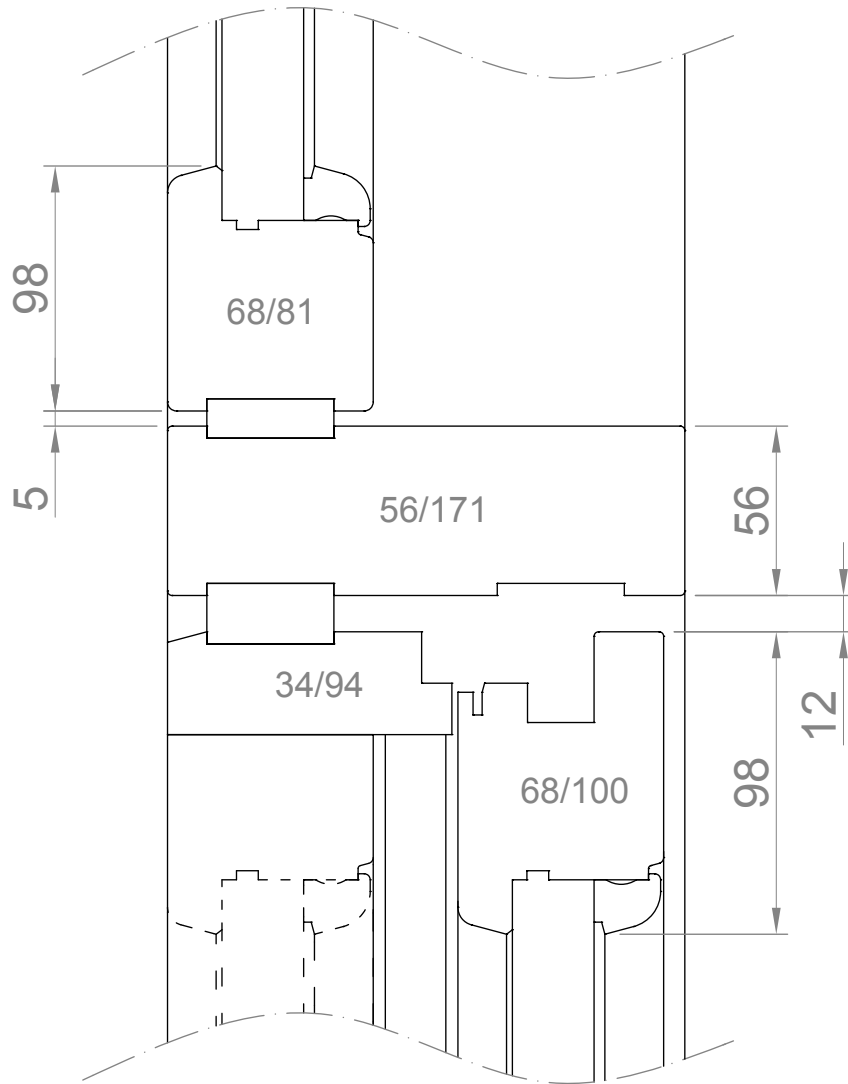

Studio 5 Old School Studios
140 Eastgate Street
Bury St Edmunds, Suffolk
IP33 1XX

phone: 01284 705 468

www.livingwoodwindows.co.uk
sales@livingwoodwindows.co.uk

Livingwood Windows Limited

Lift and Slide door 2k
Fixed light over lift slide unit double track

DATE 14/06/2010

SCALE do not scale

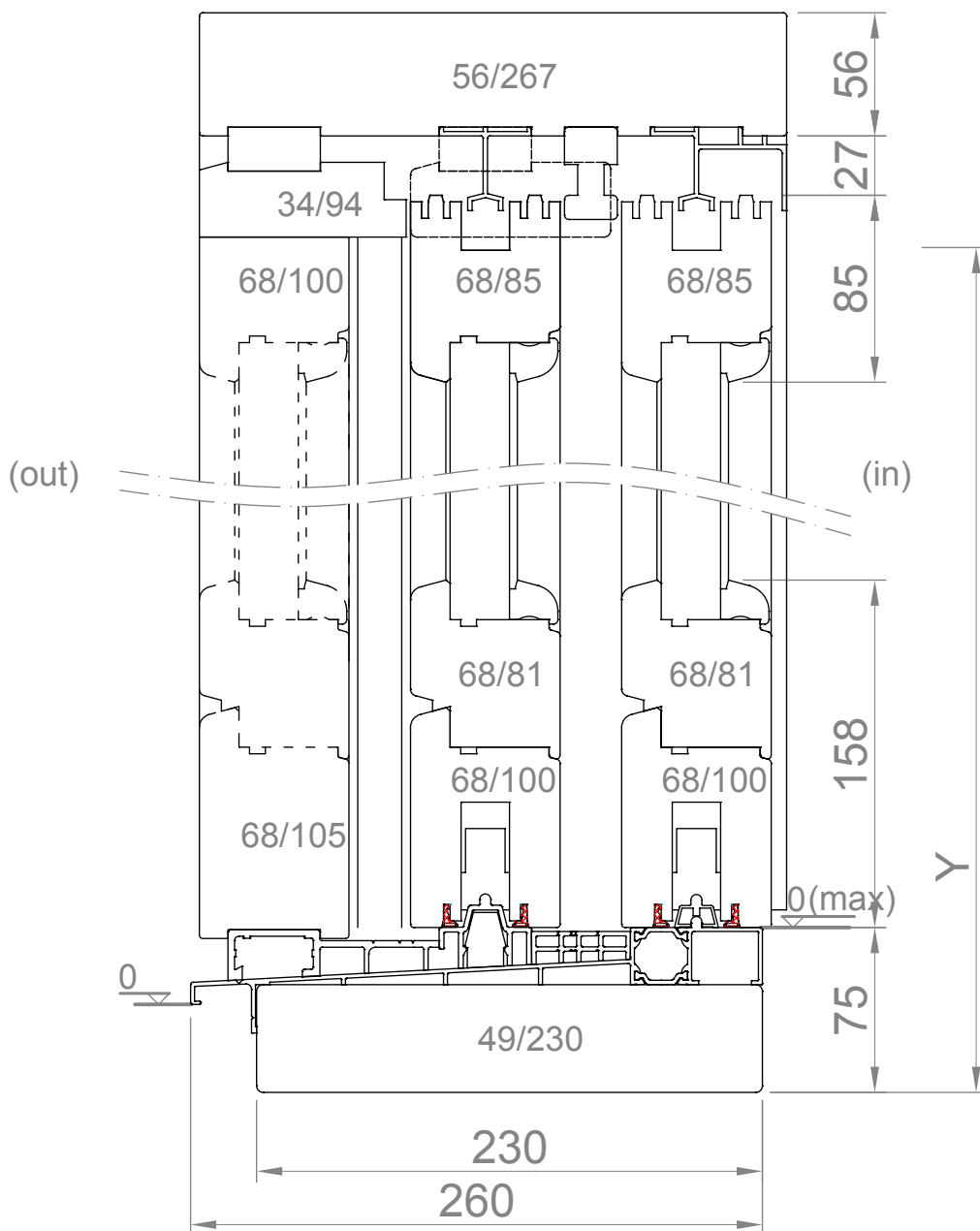
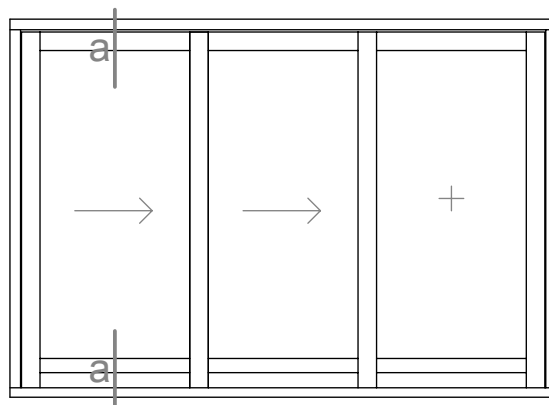

Studio 5 Old School Studios
140 Eastgate Street
Bury St Edmunds, Suffolk
IP33 1XX

phone: 01284 705 468

www.livingwoodwindows.co.uk
sales@livingwoodwindows.co.uk

Livingwood Windows Limited

Lift and Slide door 2k
Section through triple track head, threshold and leaf

DATE 14/06/2010

SCALE do not scale

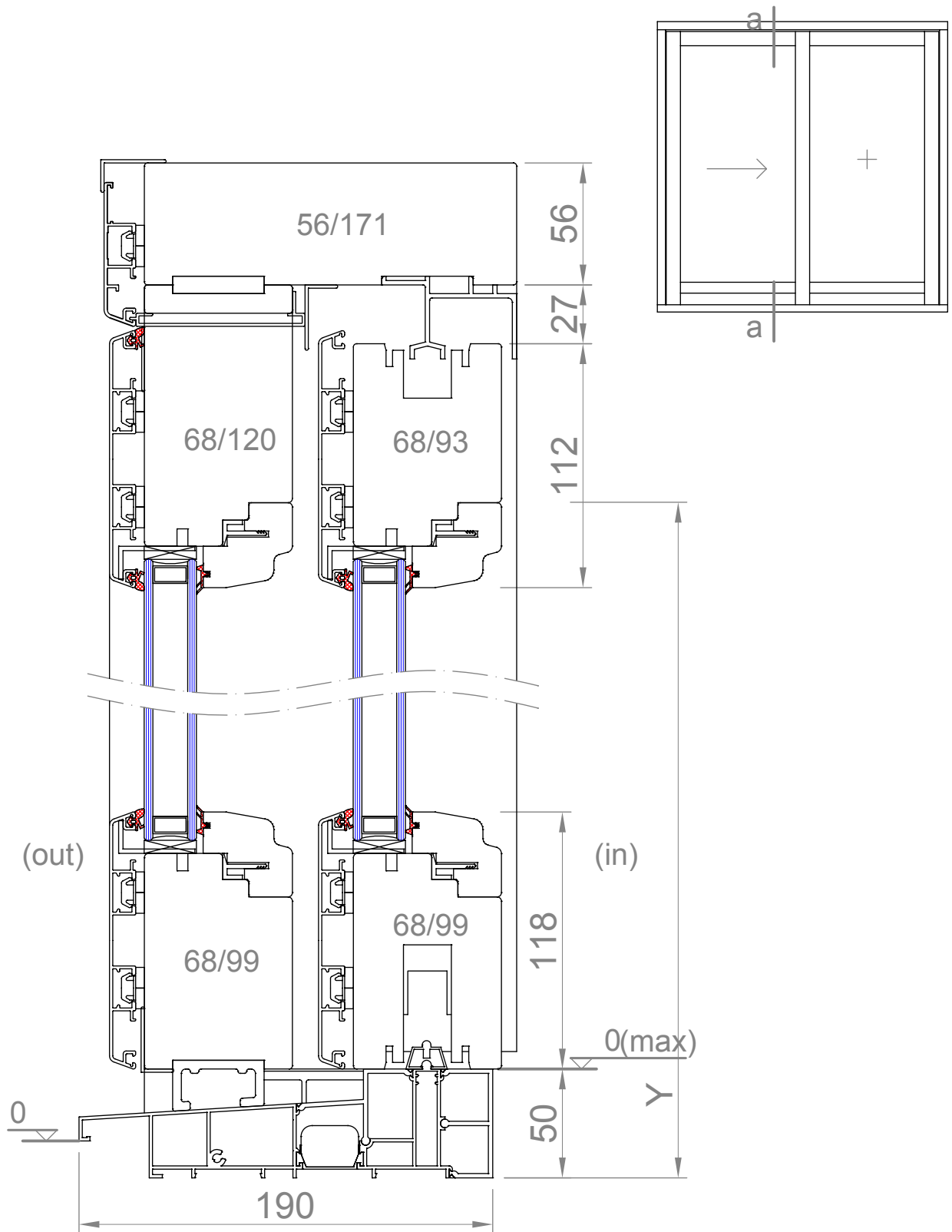

Studio 5 Old School Studios
 140 Eastgate Street
 Bury St Edmunds, Suffolk
 IP33 1XX
 phone: 01284 705 468
 www.livingwoodwindows.co.uk
 sales@livingwoodwindows.co.uk

Livingwood Windows Limited	
Alu Clad Lift and Slide door 2k Section through Head, threshold and leaf double track	
DATE	14/06/2010
SCALE	do not scale

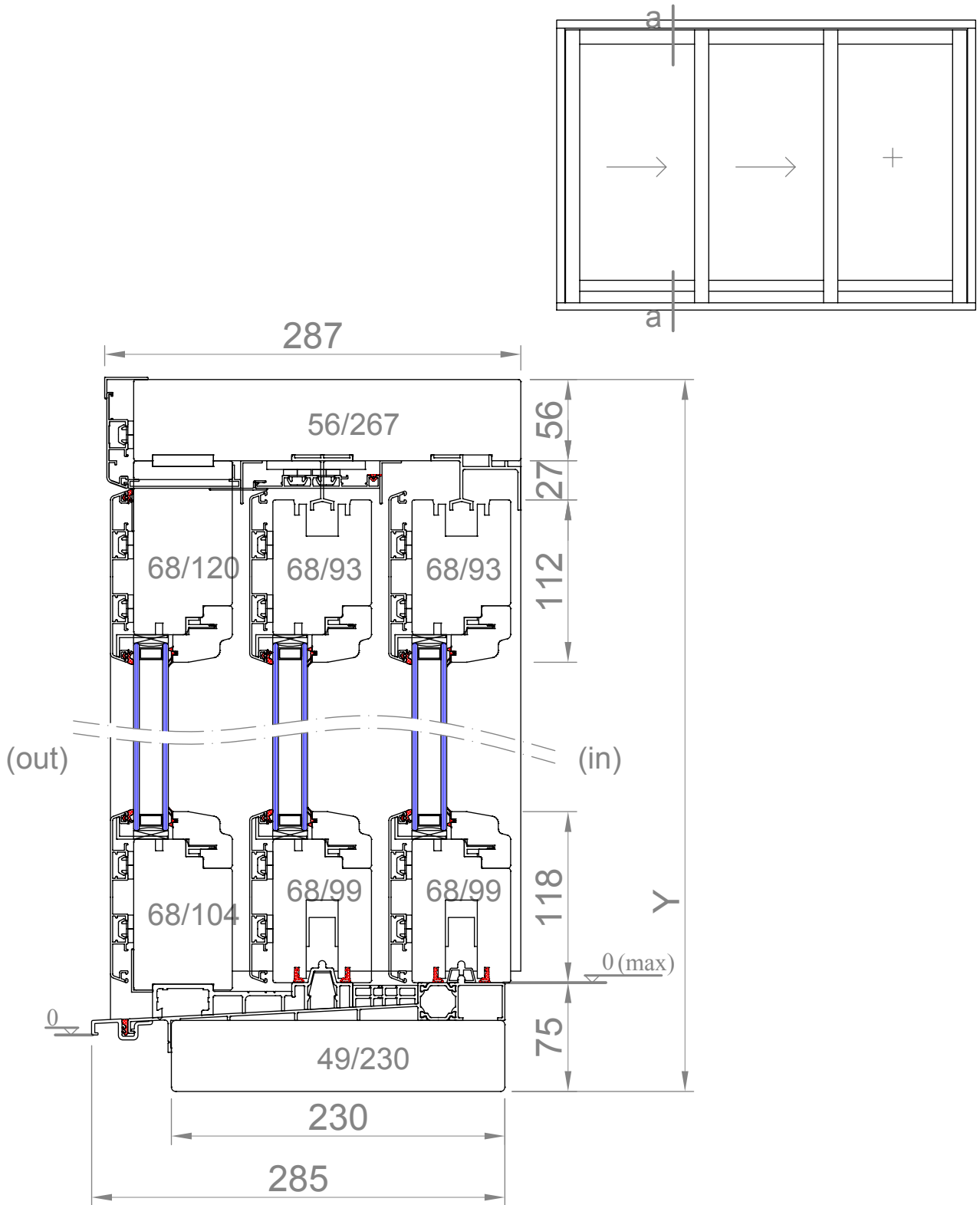

Studio 5 Old School Studios
 140 Eastgate Street
 Bury St Edmunds, Suffolk
 IP33 1XX

phone: 01284 705 468

www.livingwoodwindows.co.uk
 sales@livingwoodwindows.co.uk

Livingwood Windows Limited

Alu Clad Lift and Slide door 2k. Section through head, threshold and leaves, triple track

DATE 14/06/2010

SCALE do not scale

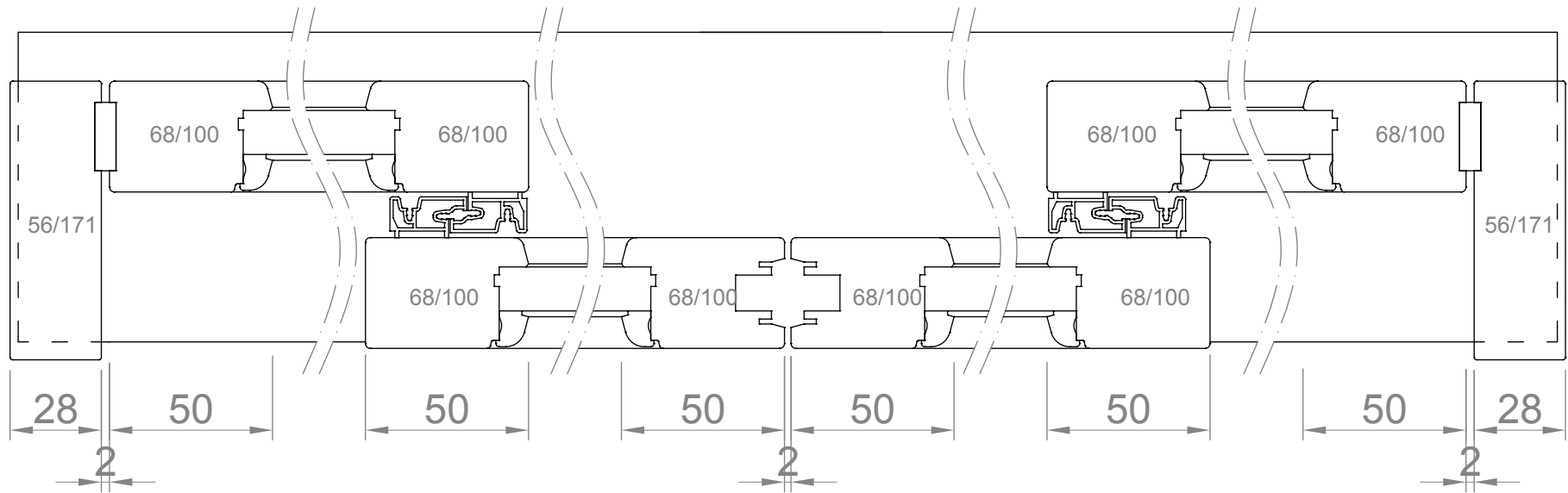
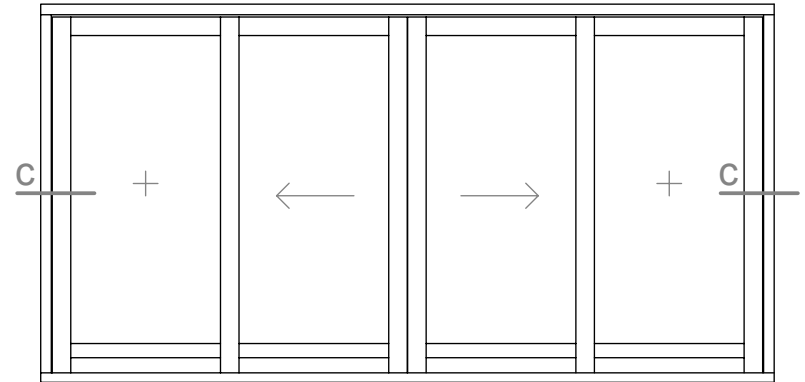

Studio 5 Old School Studios
140 Eastgate Street
Bury St Edmunds, Suffolk
IP33 1XX

phone: 01284 705 468

www.livingwoodwindows.co.uk
sales@livingwoodwindows.co.uk

Livingwood Windows Limited

Lift and Slide door 2k. Plan view through diagram E
double track configuration

DATE 14/06/2010

SCALE do not scale

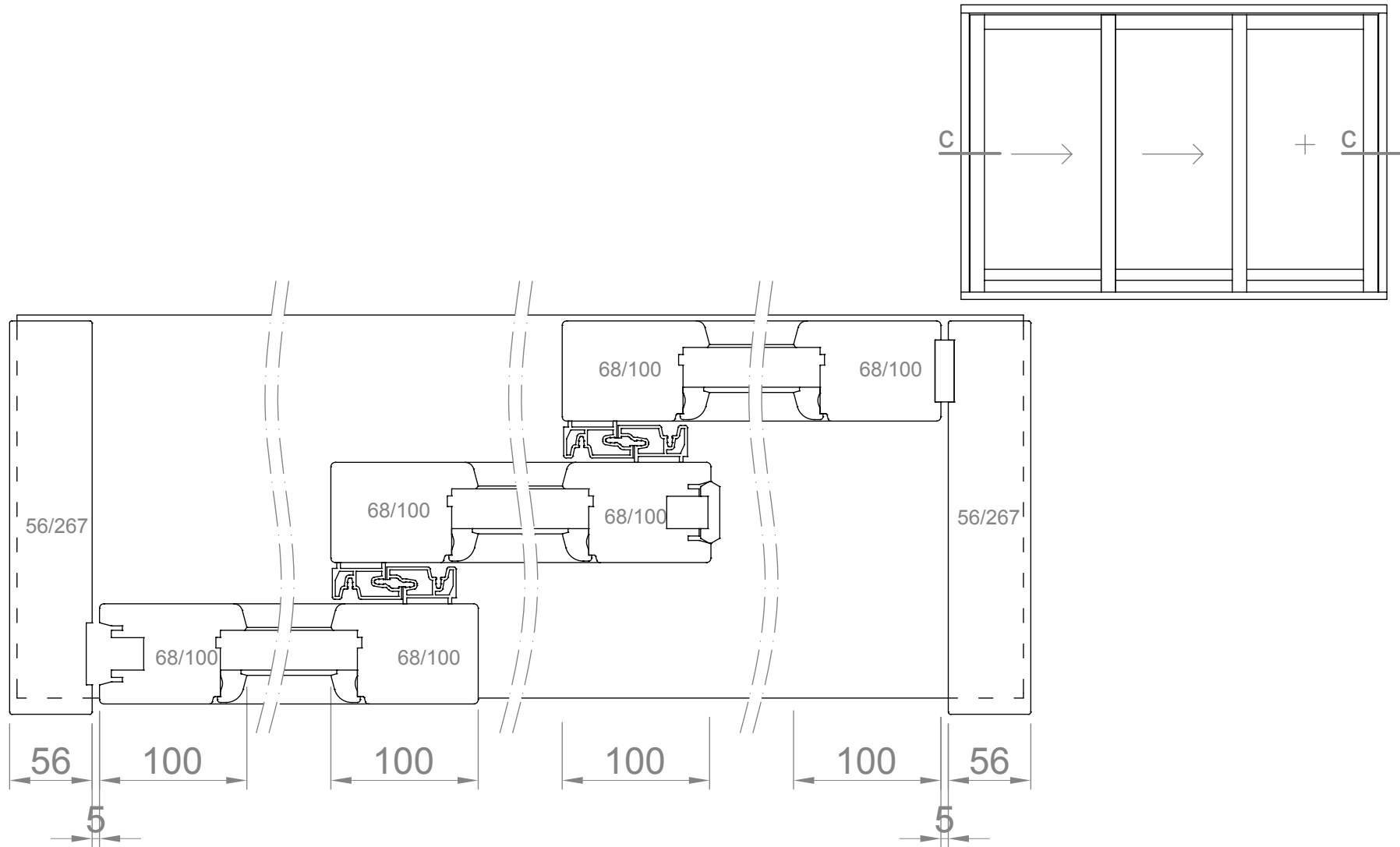

Studio 5 Old School Studios
140 Eastgate Street
Bury St Edmunds, Suffolk
IP33 1XX

phone: 01284 705 468

www.livingwoodwindows.co.uk
sales@livingwoodwindows.co.uk

Livingwood Windows Limited

Lift and Slide door 2k
Plan view through diagram H treble track configuration

DATE 14/06/2010

SCALE do not scale

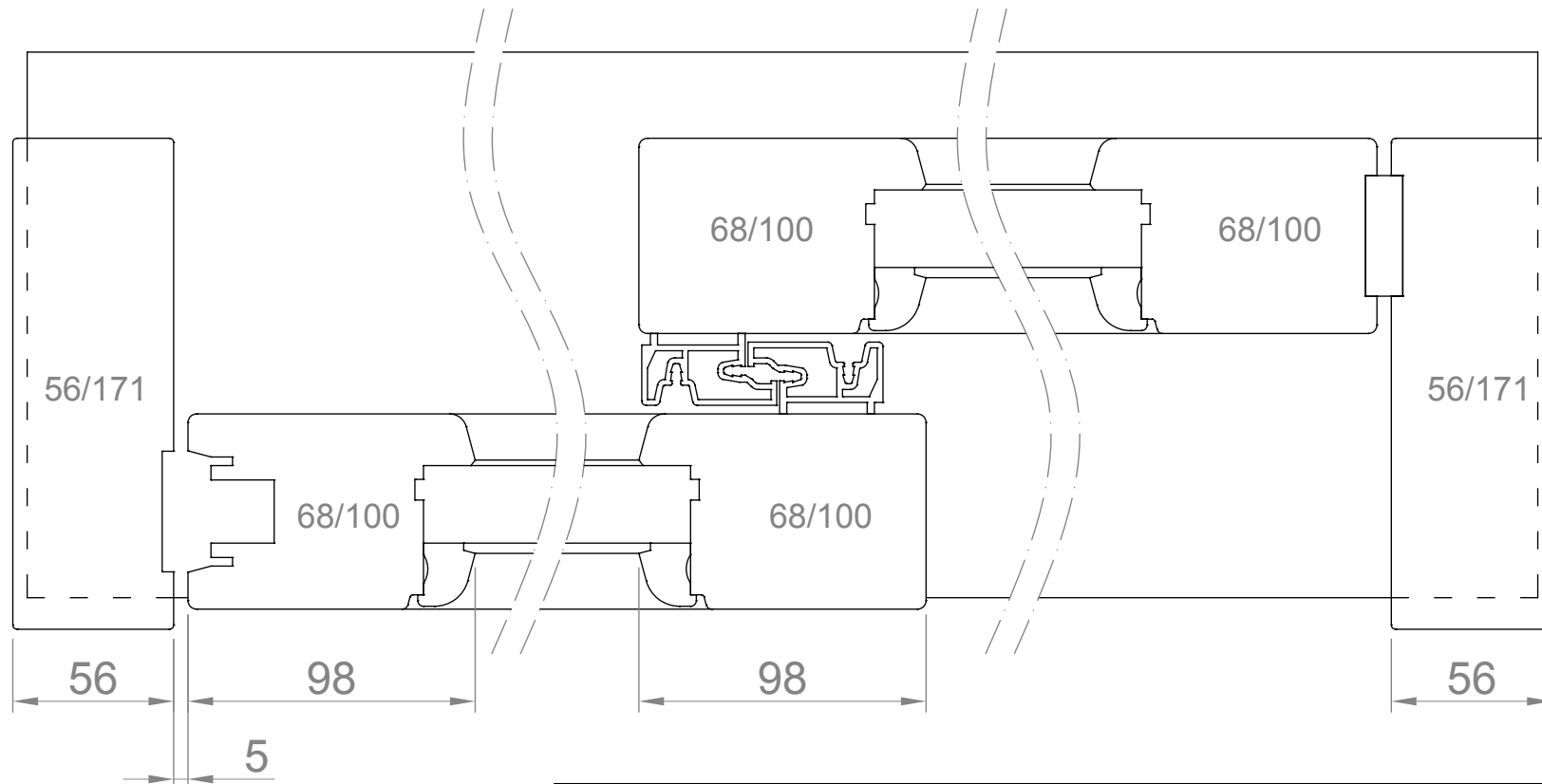
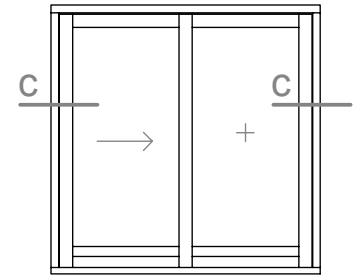

Studio 5 Old School Studios
 140 Eastgate Street
 Bury St Edmunds, Suffolk
 IP33 1XX
 phone: 01284 705 468
 www.livingwoodwindows.co.uk
 sales@livingwoodwindows.co.uk

Livingwood Windows Limited	
Lift and Slide door 2k. Plan View through Diagram A double track configuration	
DATE	14/06/2010
SCALE	do not scale

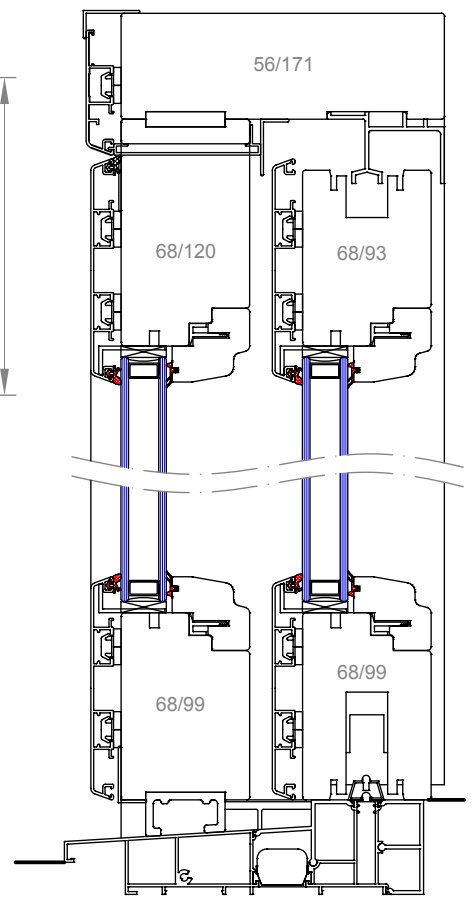
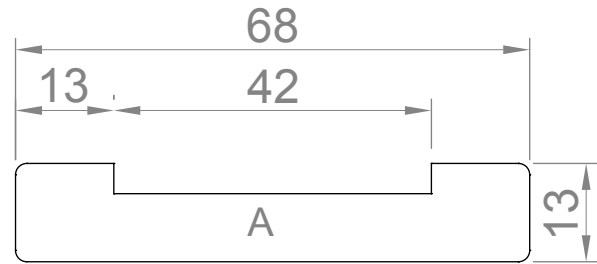
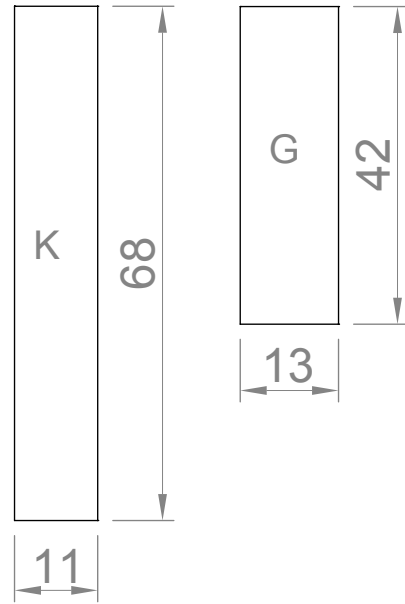
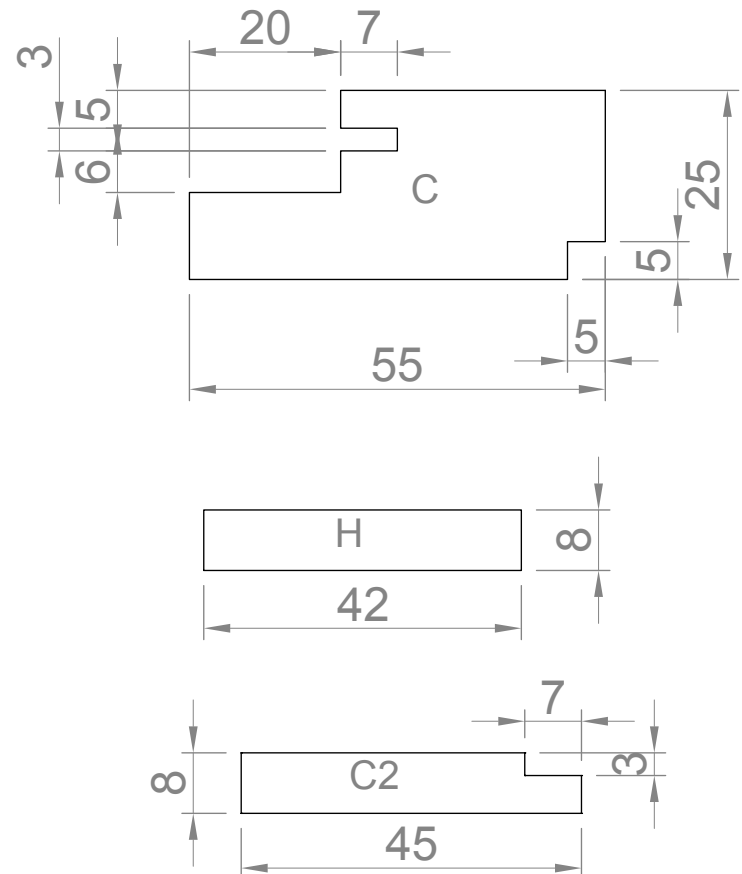
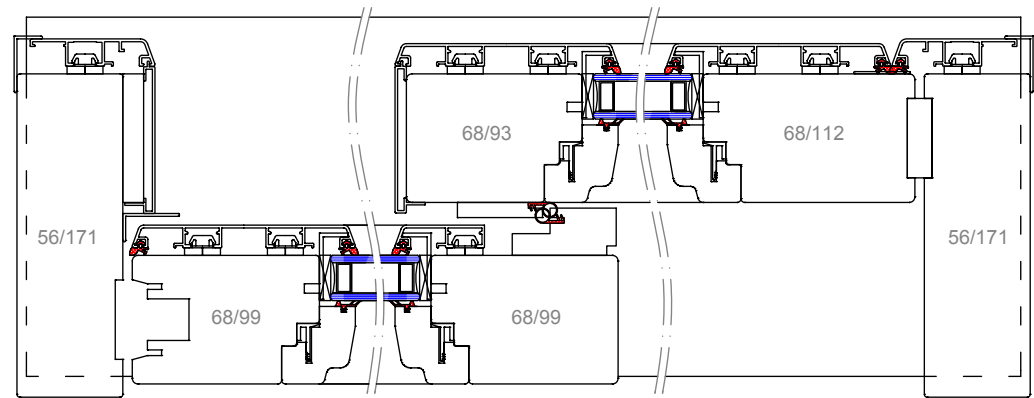

Studio 5 Old School Studios
 140 Eastgate Street
 Bury St Edmunds, Suffolk
 IP33 1XX
 phone: 01284 705 468
 www.livingwoodwindows.co.uk
 sales@livingwoodwindows.co.uk

Livingwood Windows Limited	
Alu Clad Lift and Slide Door Plan and section view through 2 track diagram A	
DATE	14/06/2010
SCALE	do not scale

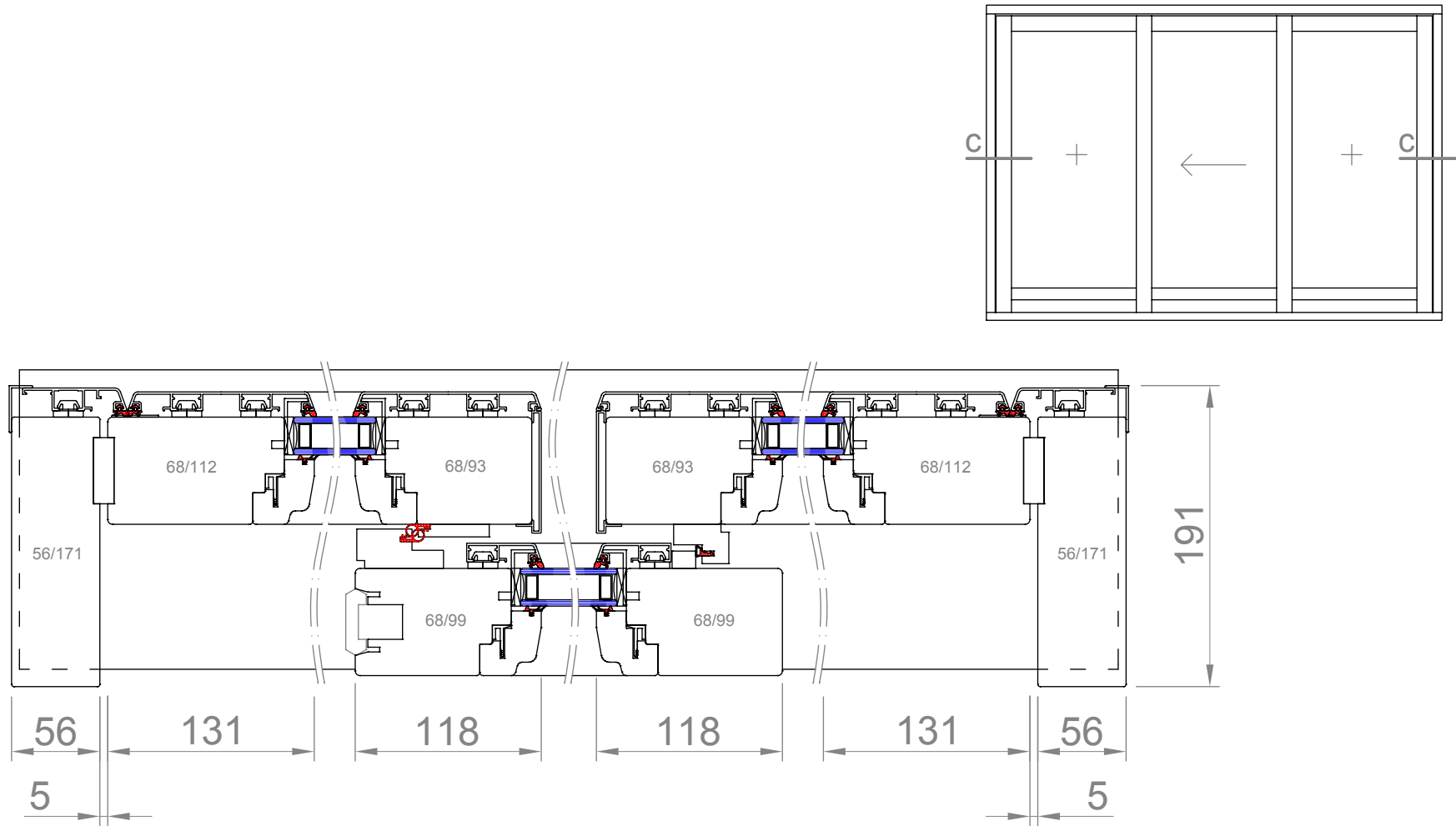

Studio 5 Old School Studios
 140 Eastgate Street
 Bury St Edmunds, Suffolk
 IP33 1XX
 phone: 01284 705 468
 www.livingwoodwindows.co.uk
 sales@livingwoodwindows.co.uk

Livingwood Windows Limited	
Alu Clad Lift and Slide door 2k. Plan and section view through diagram C 2 track system	
DATE	14/06/2010
SCALE	do not scale

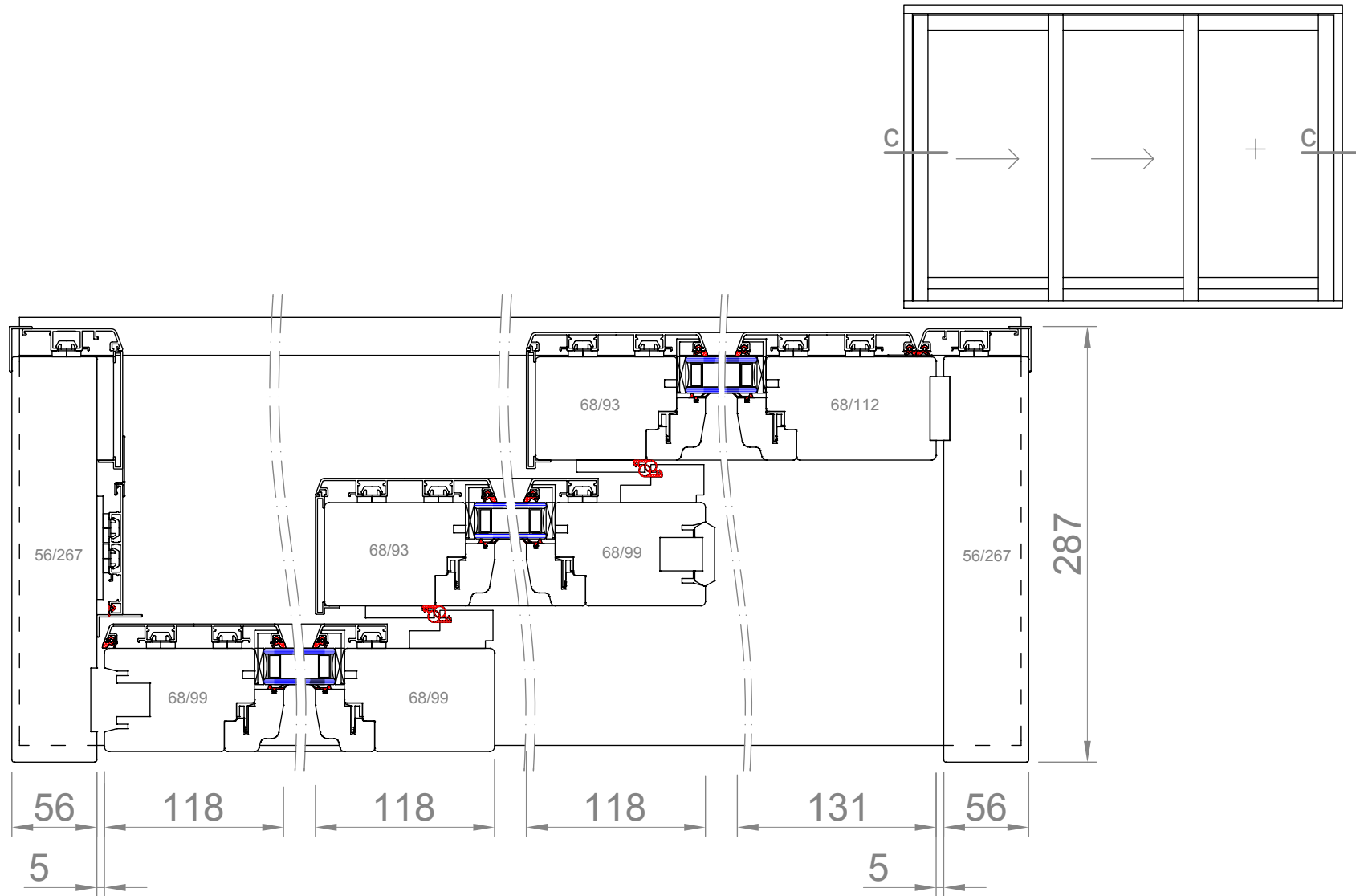

Studio 5 Old School Studios
140 Eastgate Street
Bury St Edmunds, Suffolk
IP33 1XX

phone: 01284 705 468

www.livingwoodwindows.co.uk
sales@livingwoodwindows.co.uk

Livingwood Windows Limited

Alu Clad Lift and Slide door 2k
Plan view through Diagram H treble track system

DATE 14/06/2010

SCALE do not scale

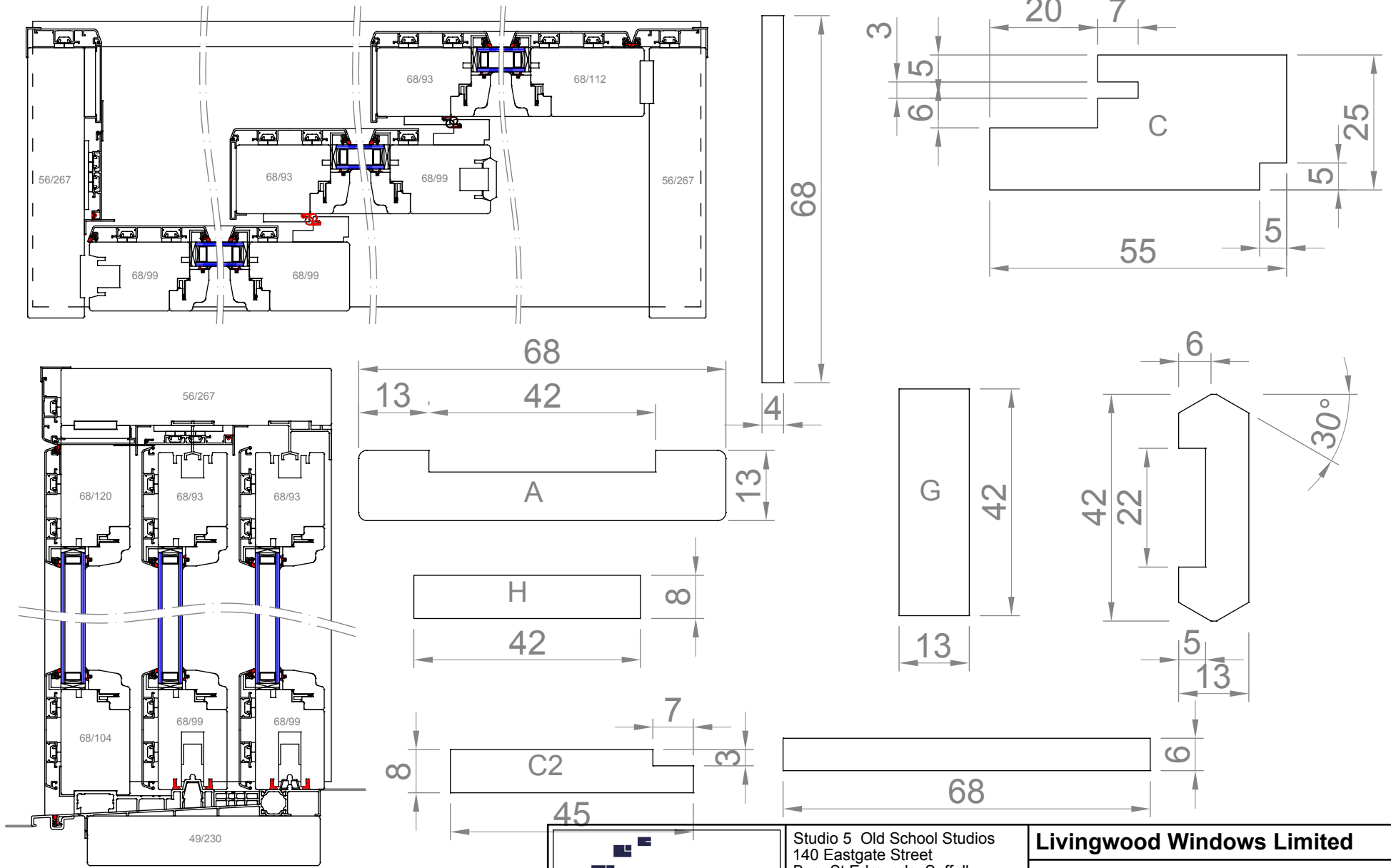

Studio 5 Old School Studios
 140 Eastgate Street
 Bury St Edmunds, Suffolk
 IP33 1XX
 phone: 01284 705 468
 www.livingwoodwindows.co.uk
 sales@livingwoodwindows.co.uk

Livingwood Windows Limited	
Alu Clad Lift and Slide door 2k. Plan and section view through diagram H, 3 track system	
DATE	14/06/2010
SCALE	do not scale

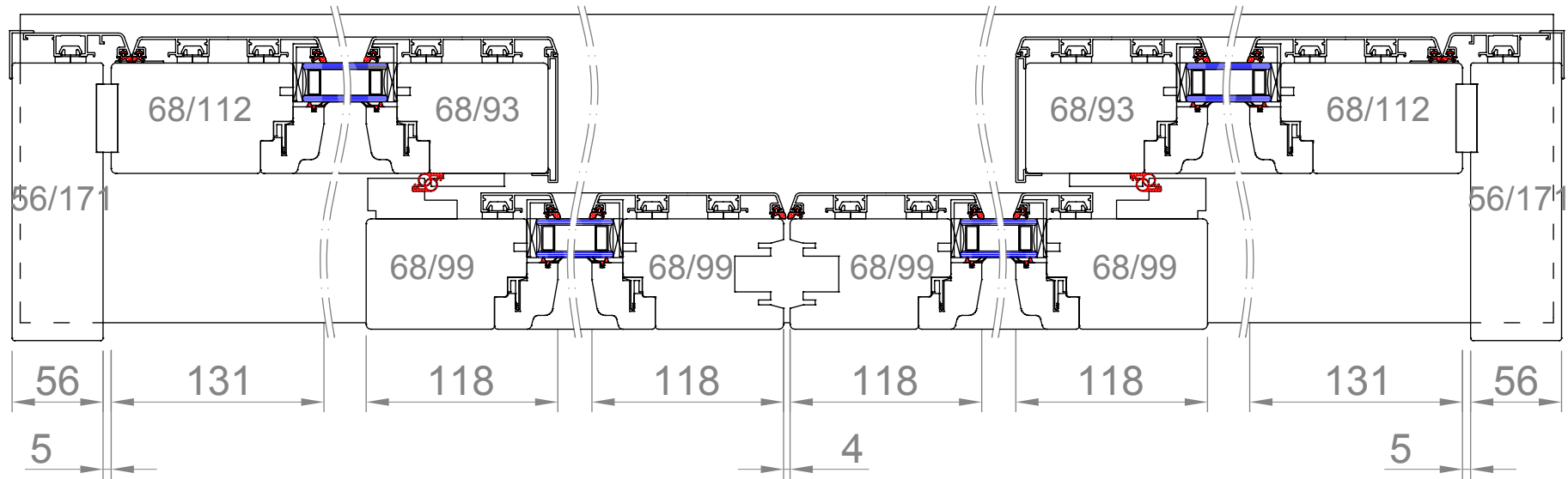
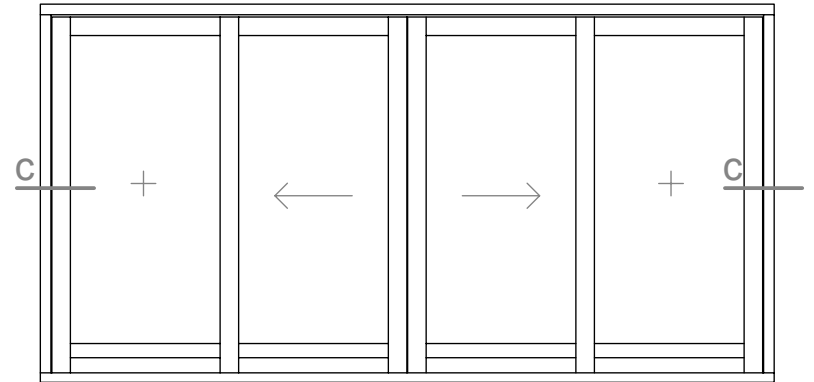

Studio 5 Old School Studios
 140 Eastgate Street
 Bury St Edmunds, Suffolk
 IP33 1XX
 phone: 01284 705 468
 www.livingwoodwindows.co.uk
 sales@livingwoodwindows.co.uk

Livingwood Windows Limited	
Alu Clad Lift and Slide door 2k Plan View through diagram E, double track system	
DATE	14/06/2010
SCALE	do not scale

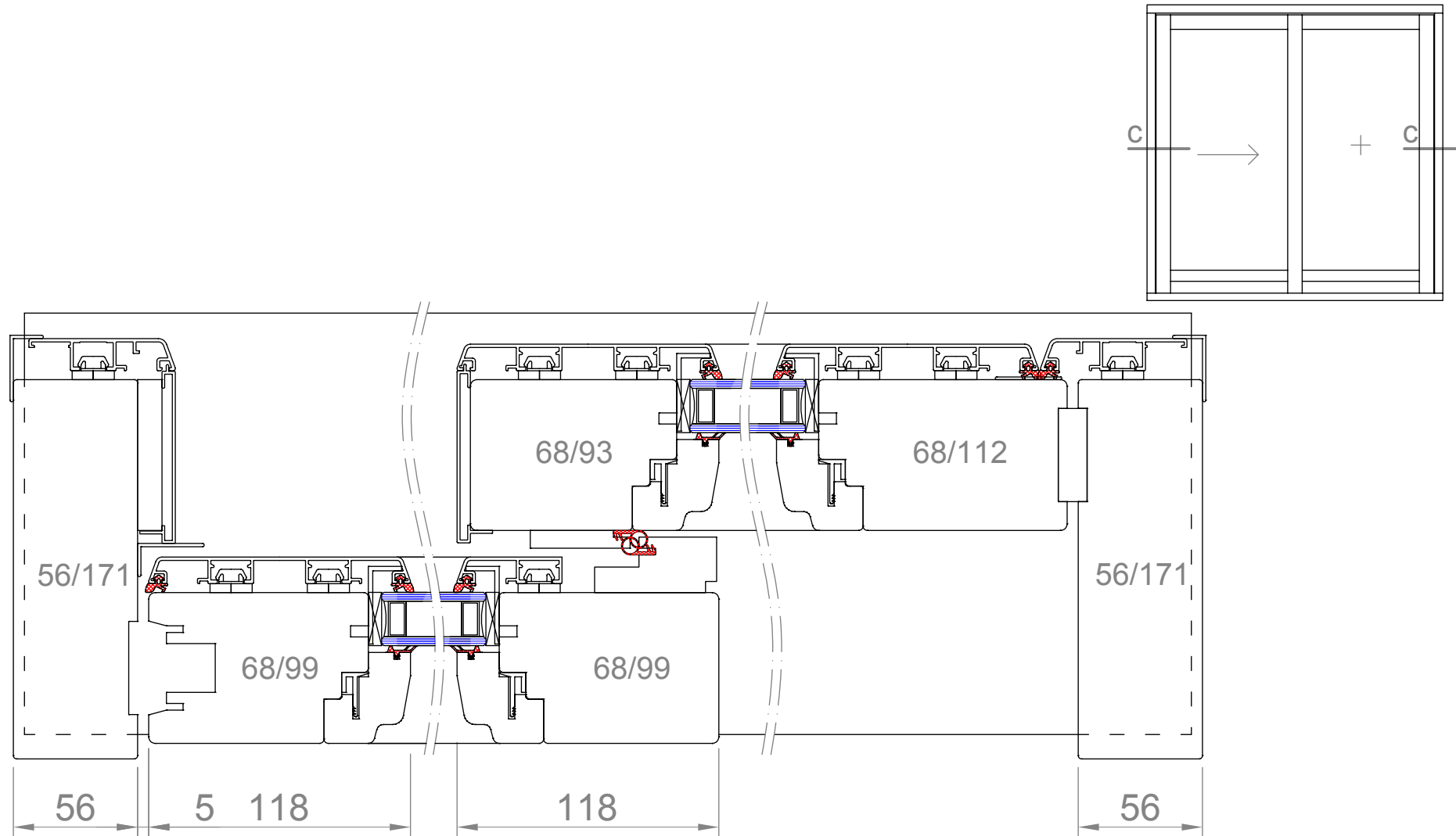

Studio 5 Old School Studios
 140 Eastgate Street
 Bury St Edmunds, Suffolk
 IP33 1XX
 phone: 01284 705 468
 www.livingwoodwindows.co.uk
 sales@livingwoodwindows.co.uk

Livingwood Windows Limited	
Alu Clad Lift and Slide door 2k Plan view through diagram A double track system	
DATE	14/06/2010
SCALE	do not scale