

Studio 5
 Old School Studios
 140 Eastgate Street
 Bury St Edmunds
 Suffolk
 IP33 1XX
 Tel: 01284 705 468
 sales@livingwoodwindows.co.uk
 www.livingwoodwindows.co.uk

Drawing No.:	V-3ACFC101	Date:	06.09.11
Drawing Title:	3k Alu-Clad Flush Casement Section Through Sill Opening Sash	Drawn By:	JSE
		Scale:	NTS

This drawing remains the property of Livingwood Windows Ltd and may not be reproduced without written permission. Livingwood Windows Ltd accepts no liability arising from any party acting on information contained within this drawing. It is advised that assistance is sought from Livingwood windows Ltd regarding matters of an individual project.

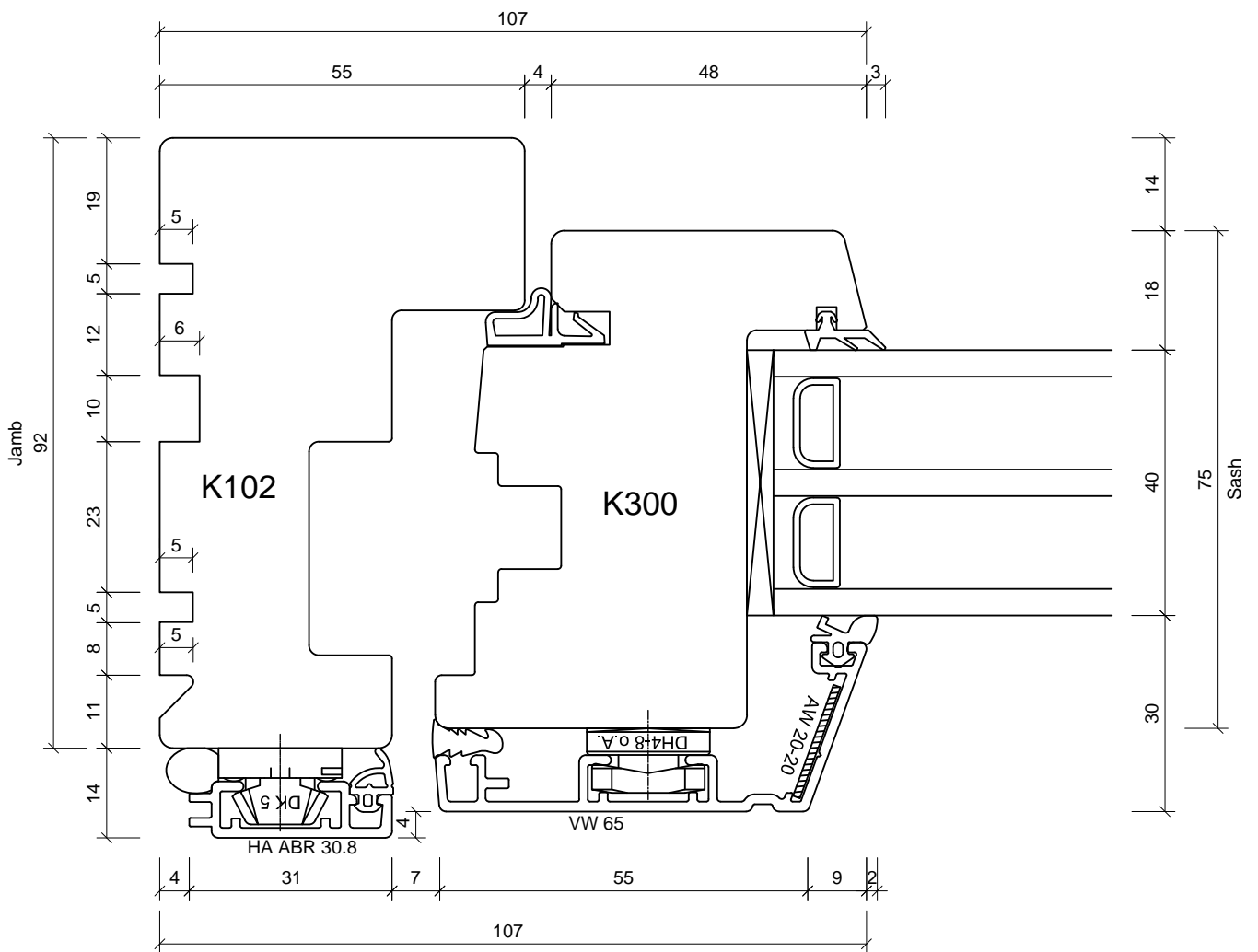
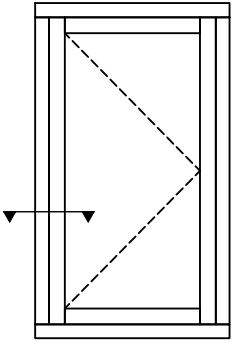

Studio 5
 Old School Studios
 140 Eastgate Street
 Bury St Edmunds
 Suffolk
 IP33 1XX
 Tel: 01284 705 468
 sales@livingwoodwindows.co.uk
 www.livingwoodwindows.co.uk

Drawing No.:	V-3ACFC102	Date:	06.09.11
Drawing Title:	3k Alu-Clad Flush Casement Section Through Jamb Opening Sash	Drawn By:	JSE
		Scale:	NTS

This drawing remains the property of Livingwood Windows Ltd and may not be reproduced without written permission.
 Livingwood Windows Ltd accepts no liability arising from any party acting on information contained within this drawing.
 It is advised that assistance is sought from Livingwood windows Ltd regarding matters of an individual project.

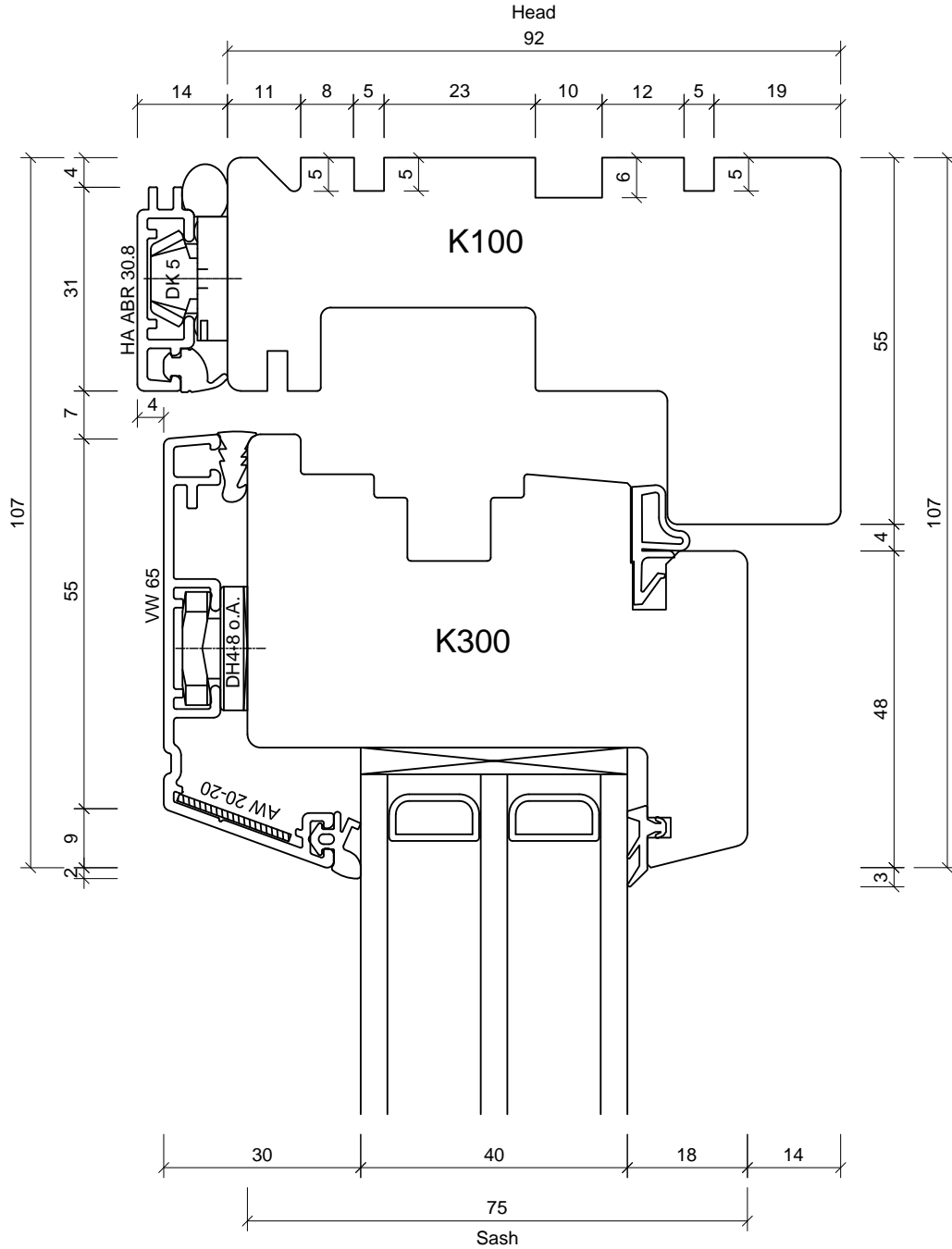
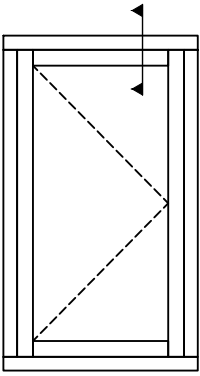

Studio 5
Old School Studios
140 Eastgate Street
Bury St Edmunds
Suffolk
IP33 1XX
Tel: 01284 705 468
sales@livingwoodwindows.co.uk
www.livingwoodwindows.co.uk

Drawing No.:
V-3ACFC103

Date:
06.09.11

Drawing Title:
3k Alu-Clad Flush Casement
Section Through Head
Opening Sash

Drawn By:
JSE

Scale:
NTS

This drawing remains the property of Livingwood Windows Ltd and may not be reproduced without written permission. Livingwood Windows Ltd accepts no liability arising from any party acting on information contained within this drawing. It is advised that assistance is sought from Livingwood windows Ltd regarding matters of an individual project.

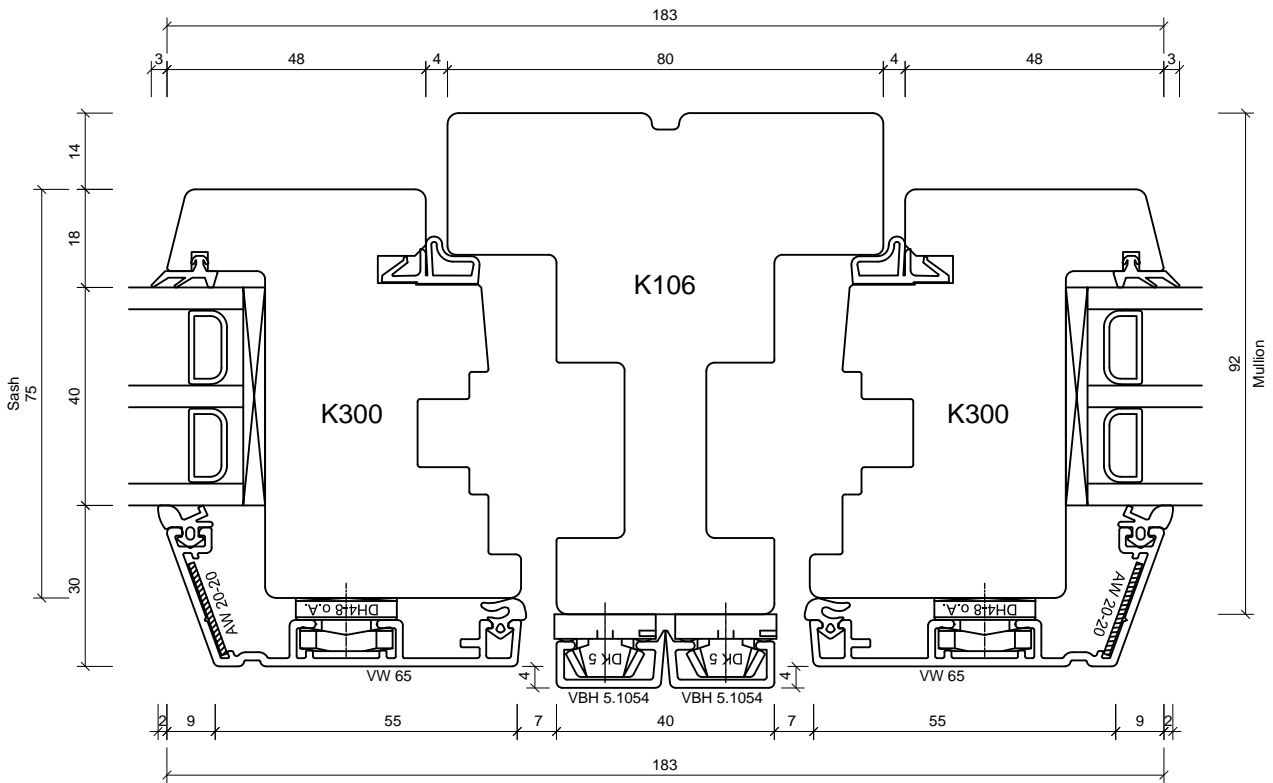
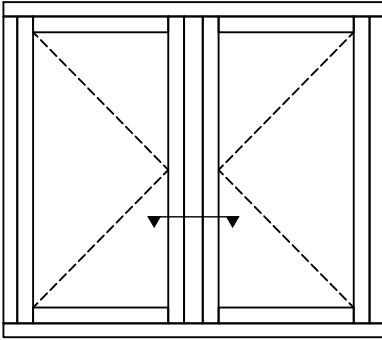

Studio 5
 Old School Studios
 140 Eastgate Street
 Bury St Edmunds
 Suffolk
 IP33 1XX
 Tel: 01284 705 468
 sales@livingwoodwindows.co.uk
 www.livingwoodwindows.co.uk

Drawing No.:	V-3ACFC104	Date:	06.09.11
Drawing Title:	3k Alu-Clad Flush Casement Section Through Mullion Opening Sash/Opening Sash	Drawn By:	JSE
		Scale:	NTS
<small>This drawing remains the property of Livingwood Windows Ltd and may not be reproduced without written permission. Livingwood Windows Ltd accepts no liability arising from any party acting on information contained within this drawing. It is advised that assistance is sought from Livingwood windows Ltd regarding matters of an individual project.</small>			

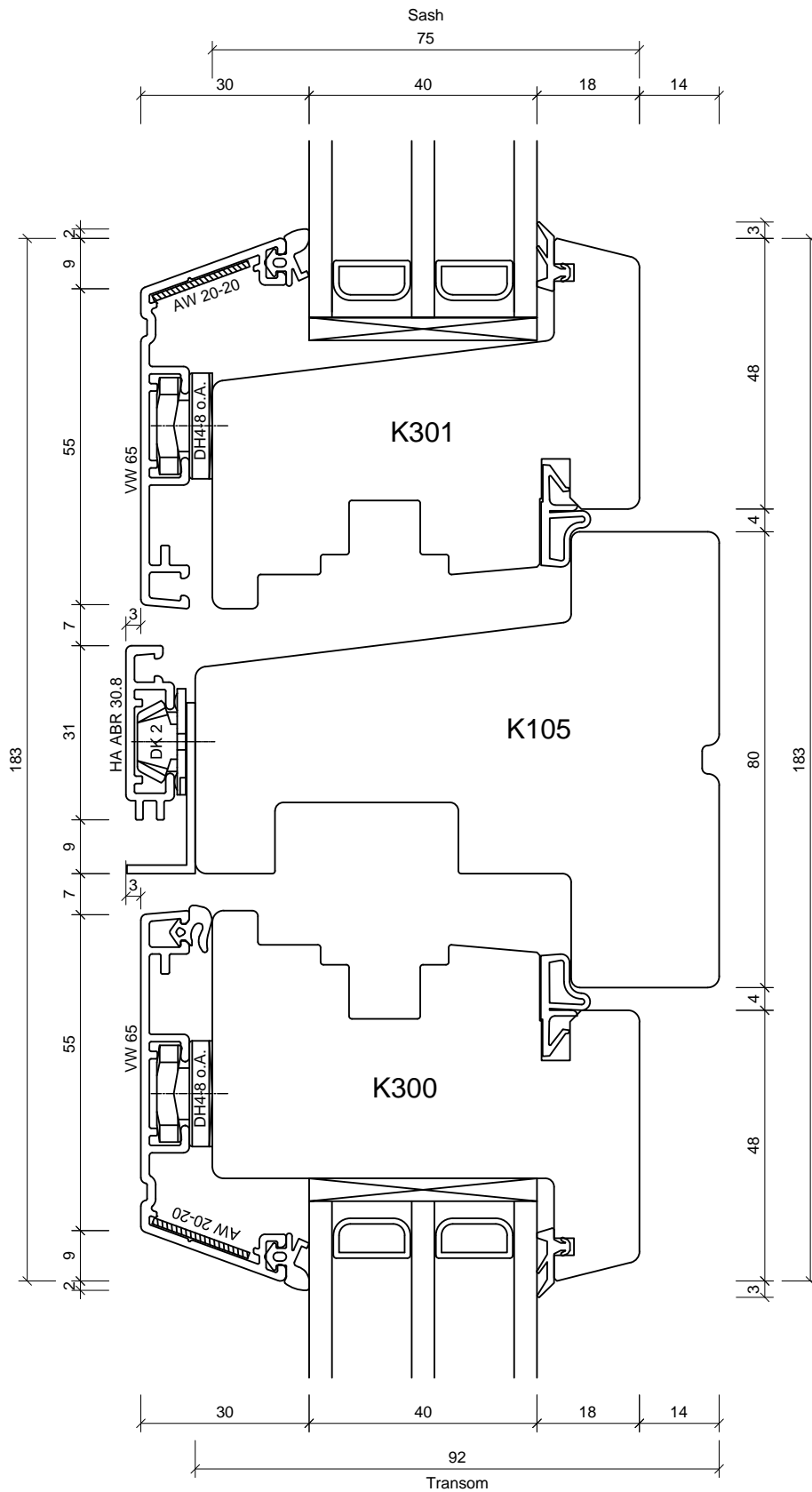
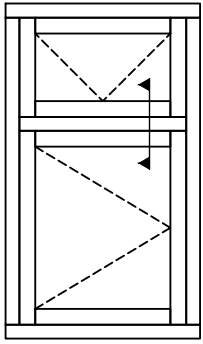

Studio 5
 Old School Studios
 140 Eastgate Street
 Bury St Edmunds
 Suffolk
 IP33 1XX
 Tel: 01284 705 468
 sales@livingwoodwindows.co.uk
 www.livingwoodwindows.co.uk

Drawing No.:	V-3ACFC105	Date:	06.09.11
Drawing Title:	3k Alu-Clad Flush Casement Section Through Transom Opening Sash/Opening Sash	Drawn By:	JSE
		Scale:	NTS

This drawing remains the property of Livingwood Windows Ltd and may not be reproduced without written permission.
 Livingwood Windows Ltd accepts no liability arising from any party acting on information contained within this drawing.
 It is advised that assistance is sought from Livingwood windows Ltd regarding matters of an individual project.

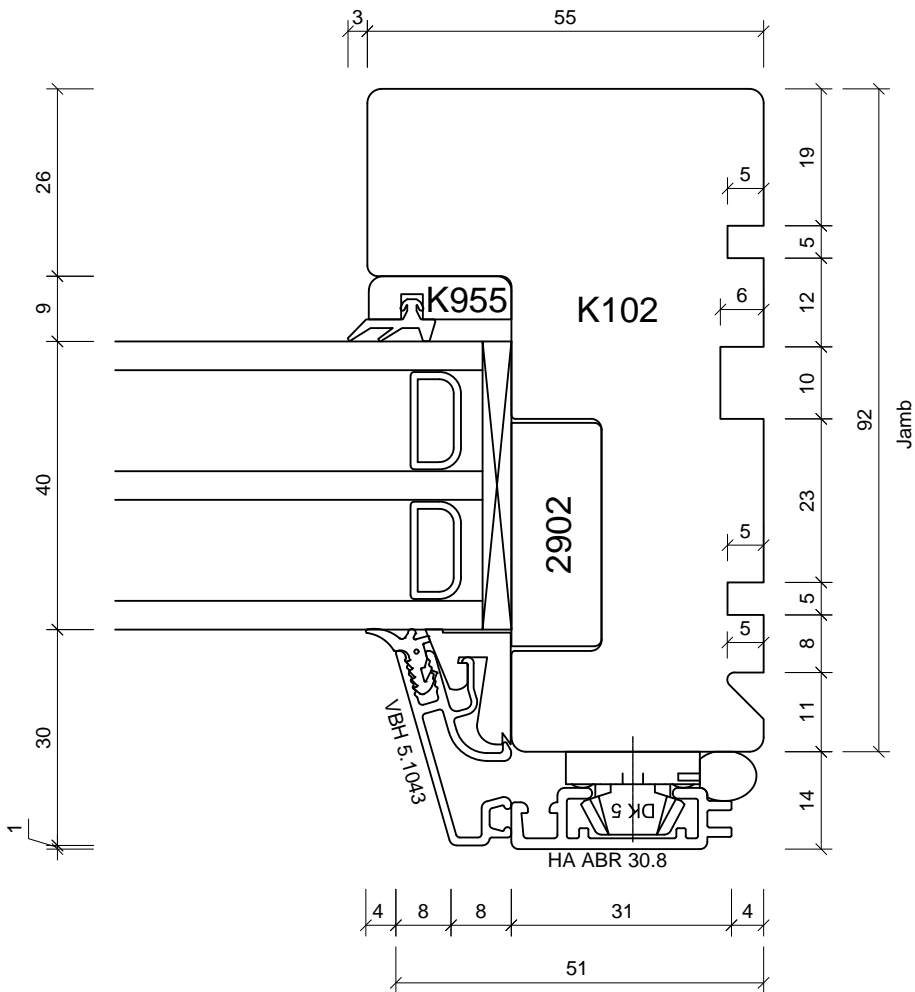
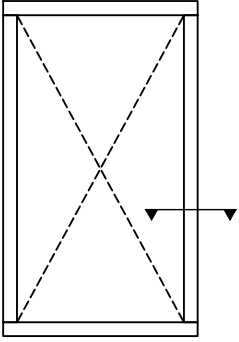

Studio 5
 Old School Studios
 140 Eastgate Street
 Bury St Edmunds
 Suffolk
 IP33 1XX
 Tel: 01284 705 468
 sales@livingwoodwindows.co.uk
 www.livingwoodwindows.co.uk

Drawing No.:
 V-3ACFC107

Date:
 06.09.11

Drawing Title:
 3k Alu-Clad Flush Casement
 Section Through Jamb
 Fixed Light

Drawn By:
 JSE

Scale:
 NTS

This drawing remains the property of Livingwood Windows Ltd and may not be reproduced without written permission.
 Livingwood Windows Ltd accepts no liability arising from any party acting on information contained within this drawing.
 It is advised that assistance is sought from Livingwood windows Ltd regarding matters of an individual project.

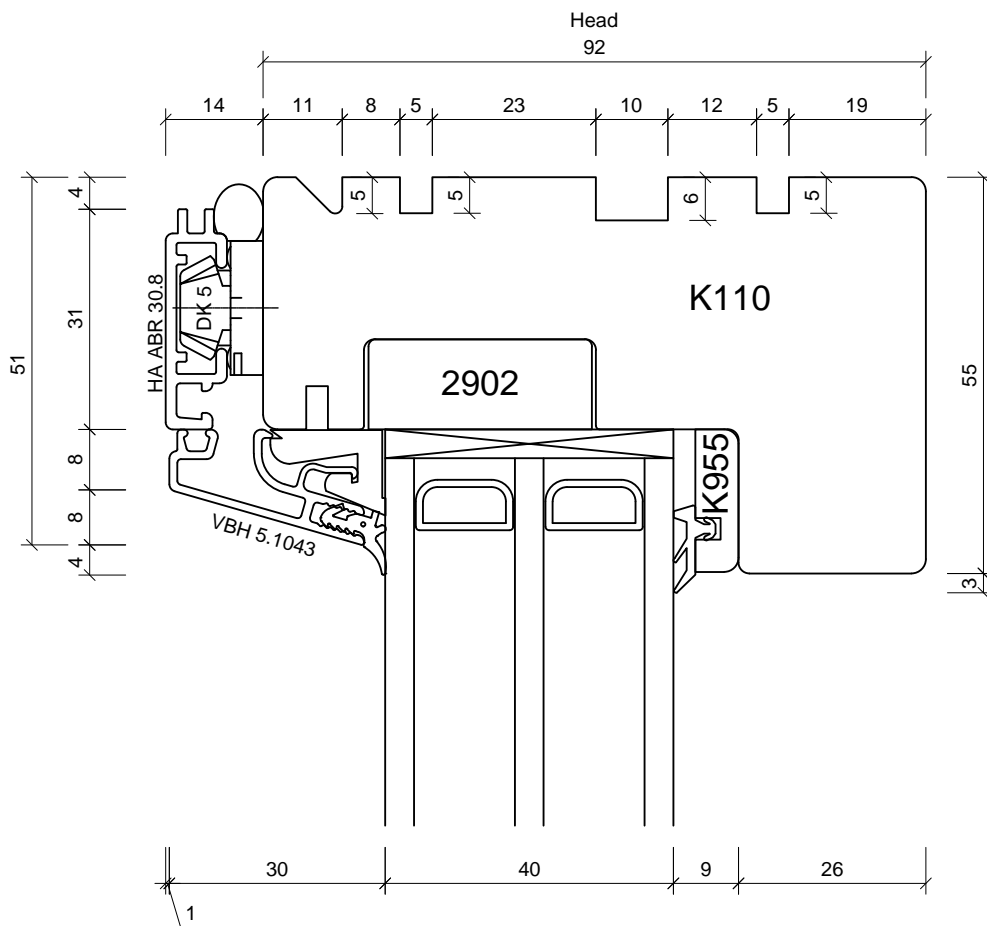
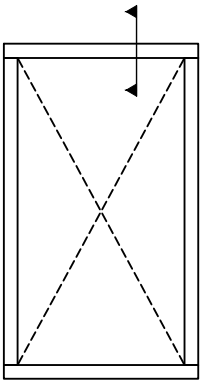

Studio 5
 Old School Studios
 140 Eastgate Street
 Bury St Edmunds
 Suffolk
 IP33 1XX
 Tel: 01284 705 468
 sales@livingwoodwindows.co.uk
 www.livingwoodwindows.co.uk

Drawing No.:
 V-3ACFC108

Date:
 06.09.11

Drawing Title:
 3k Alu-Clad Flush Casement
 Section Through Head
 Fixed Light

Drawn By:
 JSE

Scale:
 NTS

This drawing remains the property of Livingwood Windows Ltd and may not be reproduced without written permission. Livingwood Windows Ltd accepts no liability arising from any party acting on information contained within this drawing. It is advised that assistance is sought from Livingwood windows Ltd regarding matters of an individual project.

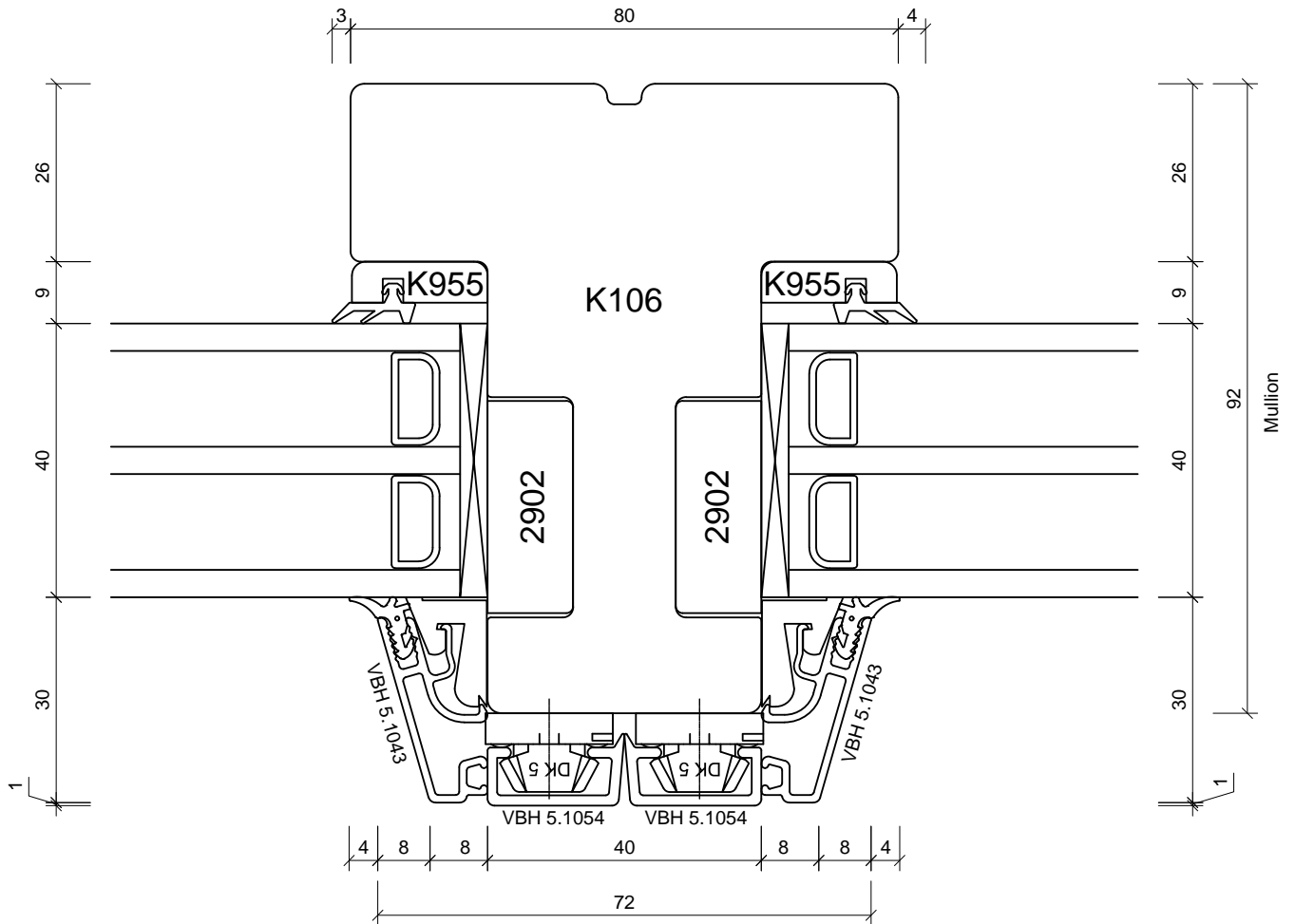
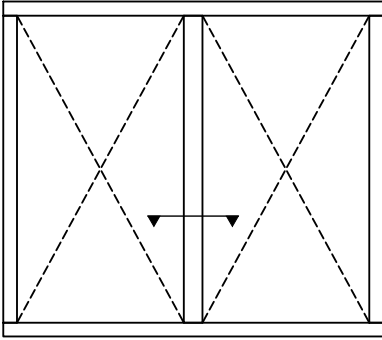

Studio 5
 Old School Studios
 140 Eastgate Street
 Bury St Edmunds
 Suffolk
 IP33 1XX
 Tel: 01284 705 468
 sales@livingwoodwindows.co.uk
 www.livingwoodwindows.co.uk

Drawing No.: V-3ACFC109	Date: 06.09.11
Drawing Title: 3k Alu-Clad Flush Casement Section Through Mullion Fixed Light/Fixed Light	Drawn By: JSE
	Scale: NTS

This drawing remains the property of Livingwood Windows Ltd and may not be reproduced without written permission. Livingwood Windows Ltd accepts no liability arising from any party acting on information contained within this drawing. It is advised that assistance is sought from Livingwood windows Ltd regarding matters of an individual project.

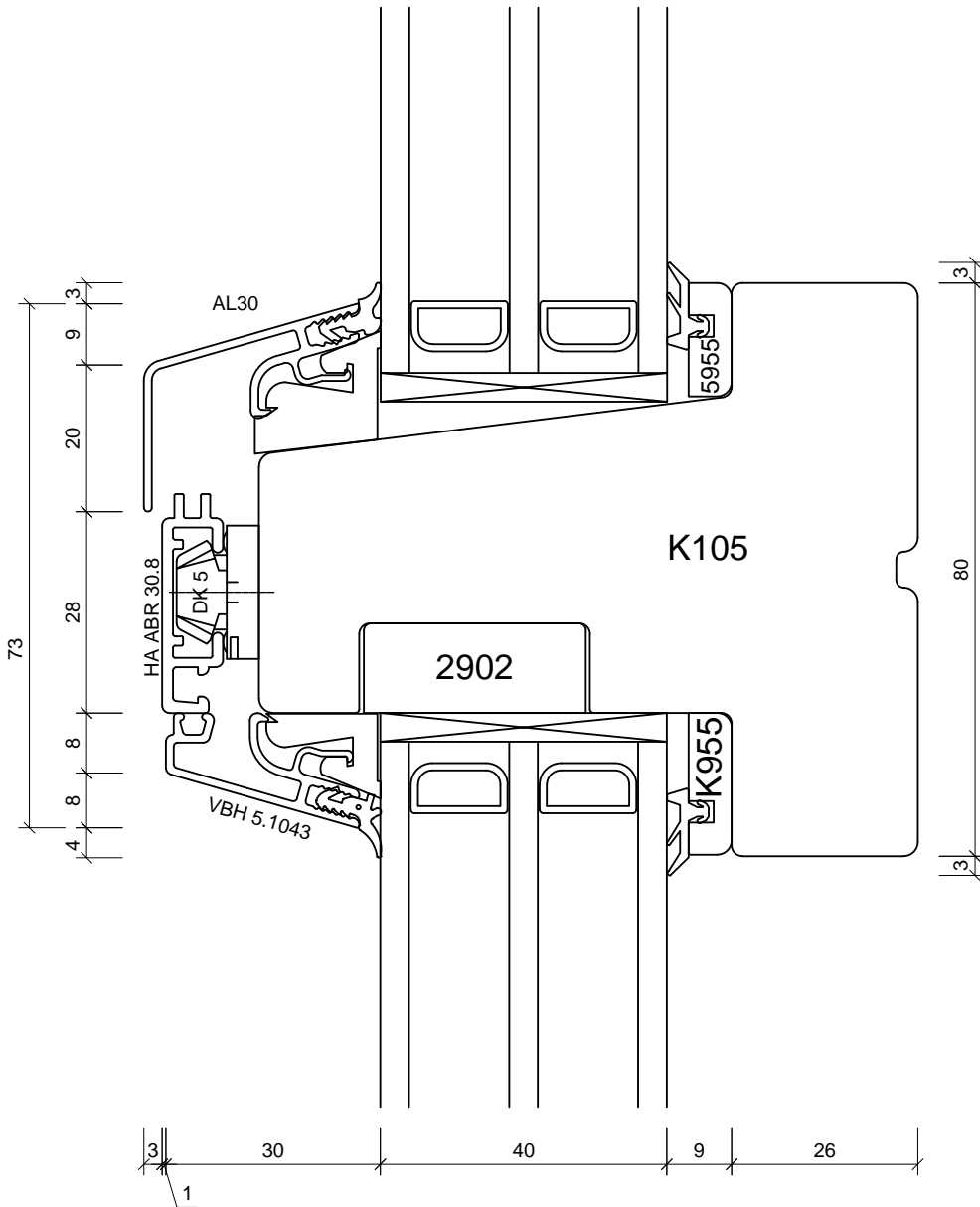
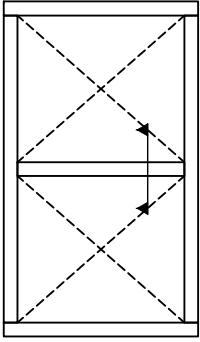

Studio 5
 Old School Studios
 140 Eastgate Street
 Bury St Edmunds
 Suffolk
 IP33 1XX
 Tel: 01284 705 468
 sales@livingwoodwindows.co.uk
 www.livingwoodwindows.co.uk

Drawing No.:	V-3ACFC110	Date:	06.09.11
Drawing Title:	3k Alu-Clad Flush Casement Section Through Transom Fixed Light/Fixed Light	Drawn By:	JSE
		Scale:	NTS
<small>This drawing remains the property of Livingwood Windows Ltd and may not be reproduced without written permission. Livingwood Windows Ltd accepts no liability arising from any party acting on information contained within this drawing. It is advised that assistance is sought from Livingwood windows Ltd regarding matters of an individual project.</small>			

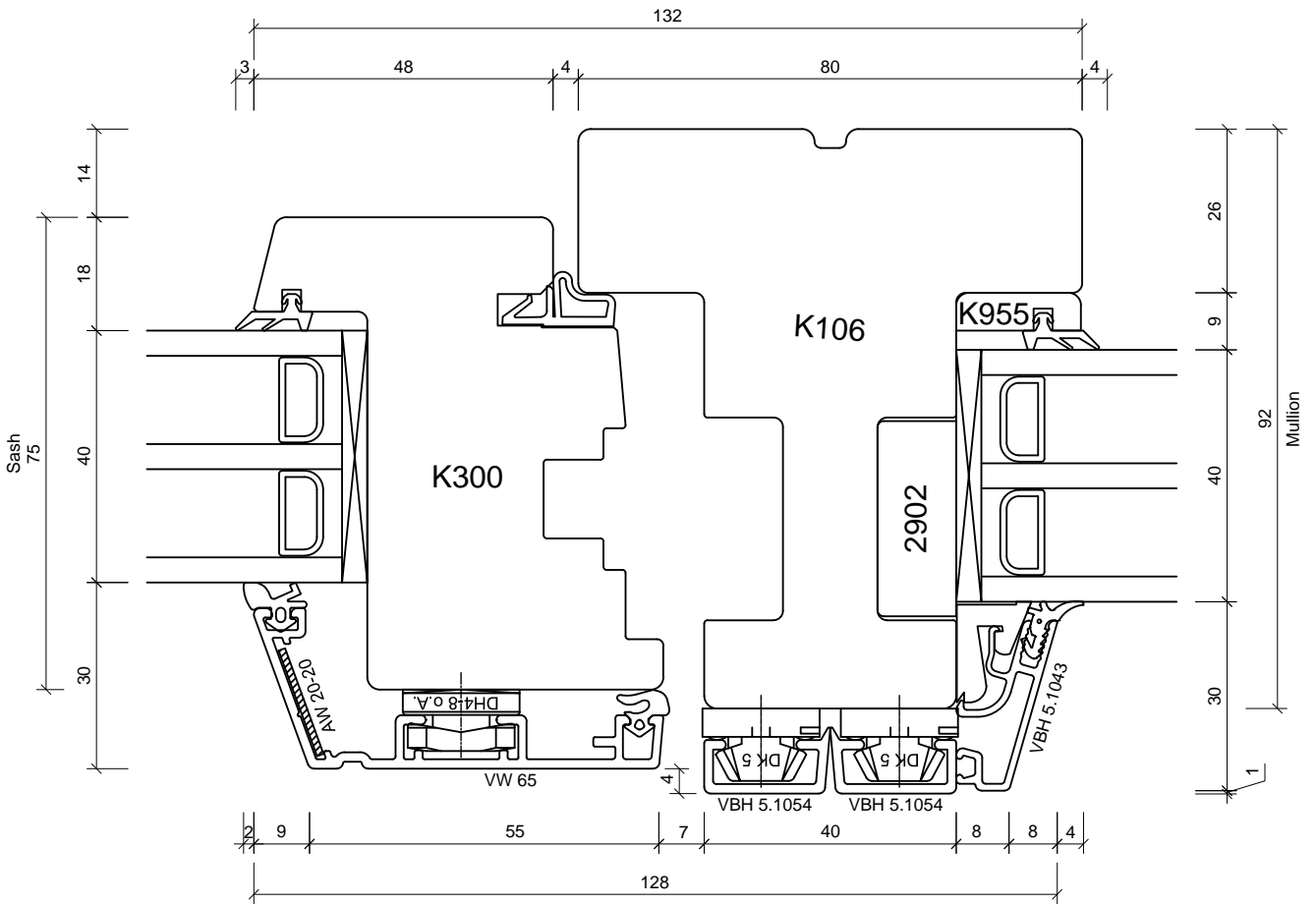
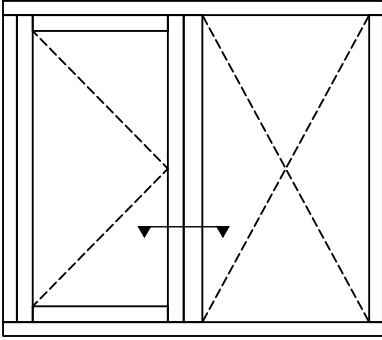

Studio 5
 Old School Studios
 140 Eastgate Street
 Bury St Edmunds
 Suffolk
 IP33 1XX
 Tel: 01284 705 468
 sales@livingwoodwindows.co.uk
 www.livingwoodwindows.co.uk

Drawing No.:	V-3ACFC111	Date:	06.09.11
Drawing Title:	3k Alu-Clad Flush Casement Section Through Mullion Opening Sash/Fixed Light	Drawn By:	JSE
		Scale:	NTS

This drawing remains the property of Livingwood Windows Ltd and may not be reproduced without written permission.
 Livingwood Windows Ltd accepts no liability arising from any party acting on information contained within this drawing.
 It is advised that assistance is sought from Livingwood windows Ltd regarding matters of an individual project.

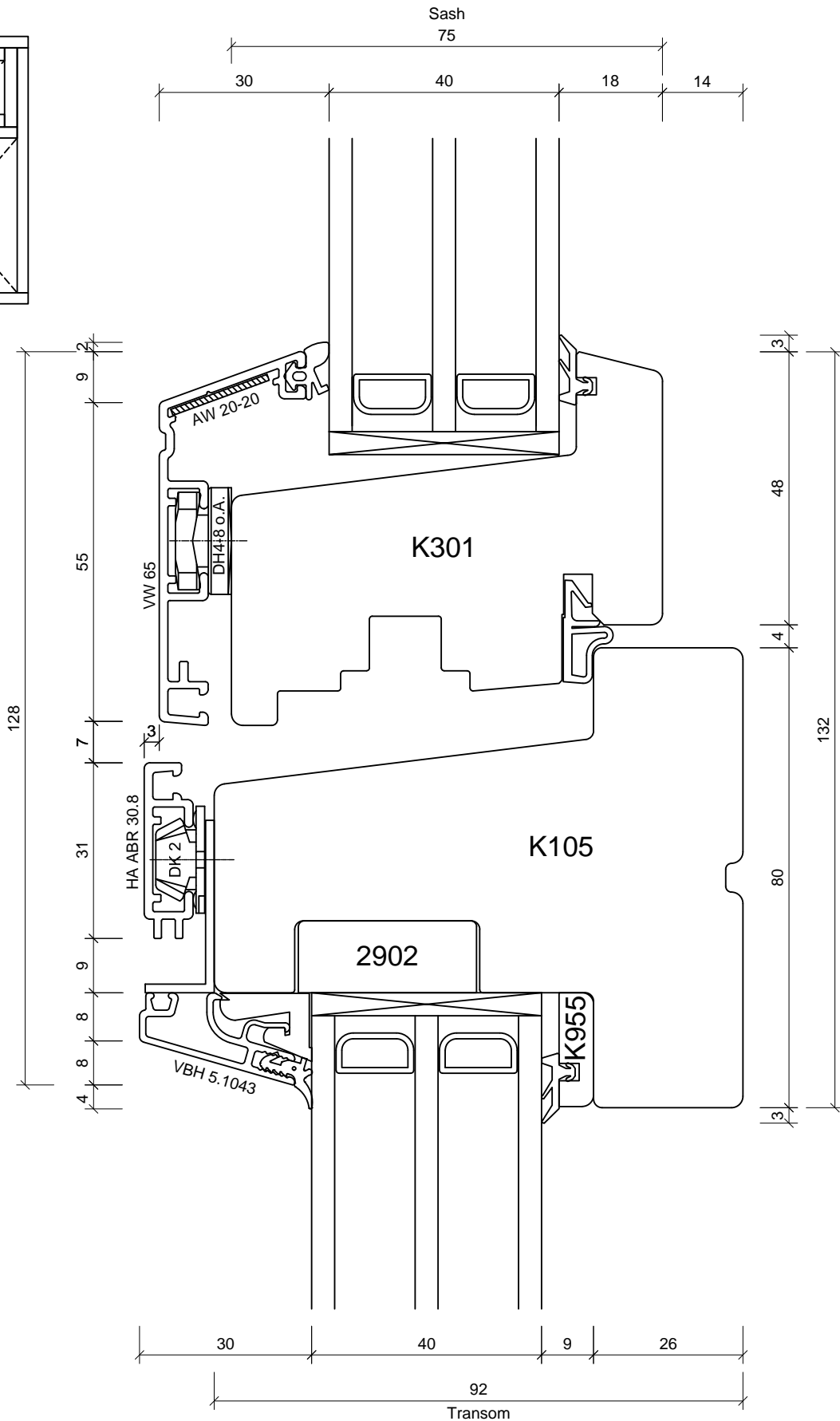
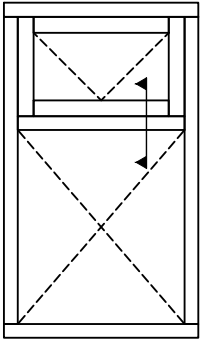

Studio 5
 Old School Studios
 140 Eastgate Street
 Bury St Edmunds
 Suffolk
 IP33 1XX
 Tel: 01284 705 468
 sales@livingwoodwindows.co.uk
 www.livingwoodwindows.co.uk

Drawing No.:	V-3ACFC112	Date:	06.09.11
Drawing Title:	3k Alu-Clad Flush Casement Section Through Transom Opening Sash Over Fixed Light	Drawn By:	JSE
		Scale:	NTS
<small>This drawing remains the property of Livingwood Windows Ltd and may not be reproduced without written permission. Livingwood Windows Ltd accepts no liability arising from any party acting on information contained within this drawing. It is advised that assistance is sought from Livingwood windows Ltd regarding matters of an individual project.</small>			

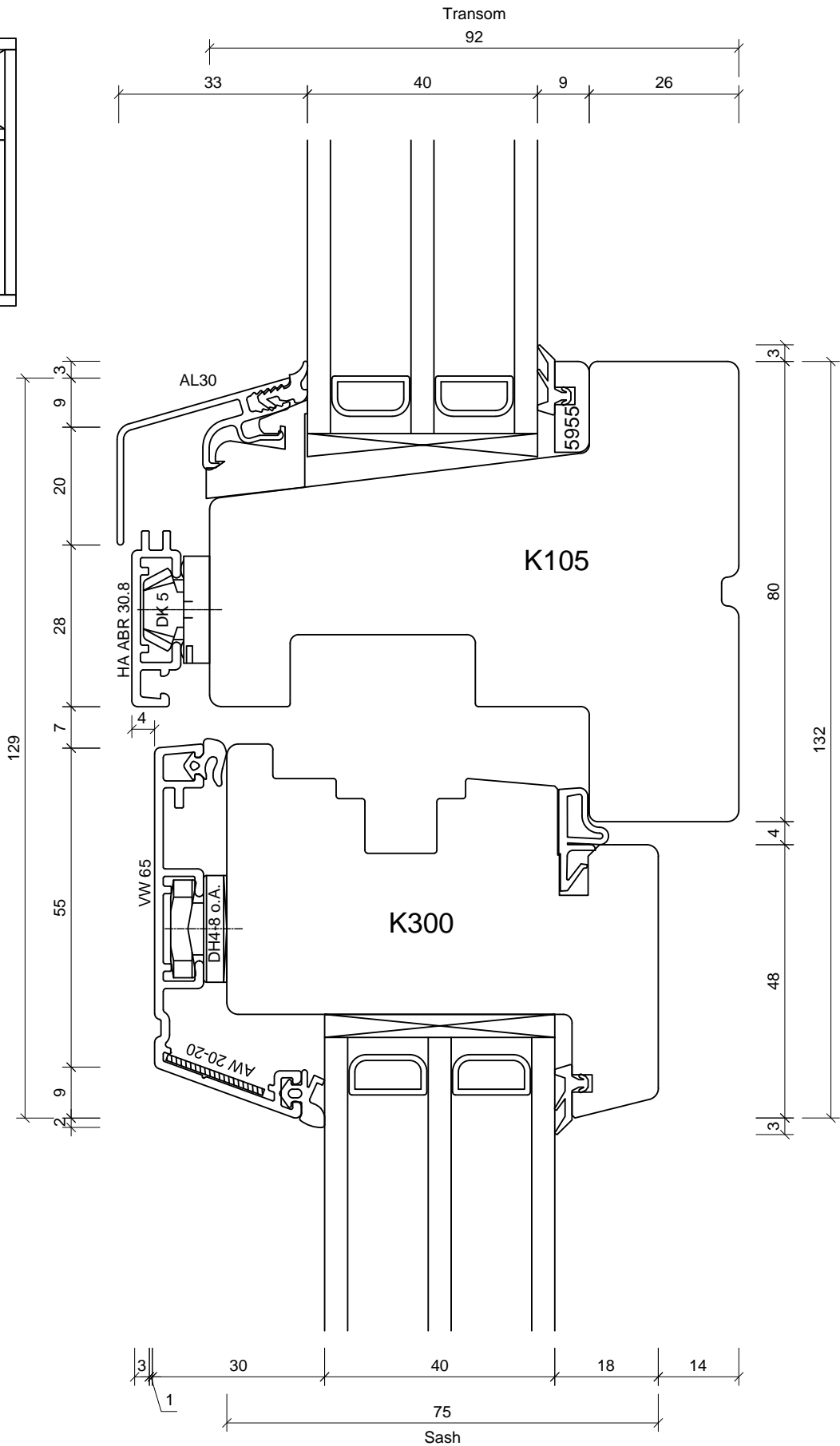
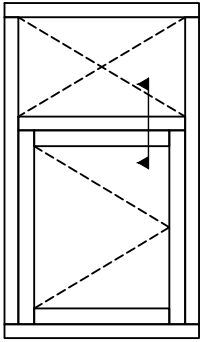

Studio 5
 Old School Studios
 140 Eastgate Street
 Bury St Edmunds
 Suffolk
 IP33 1XX
 Tel: 01284 705 468
 sales@livingwoodwindows.co.uk
 www.livingwoodwindows.co.uk

Drawing No.:
 V-3ACFC113

Date:
 06.09.11

Drawing Title:
 3k Alu-Clad Flush Casement
 Section Through Transom
 Fixed Light Over Opening Sash

Drawn By:
 JSE
 Scale:
 NTS

This drawing remains the property of Livingwood Windows Ltd and may not be reproduced without written permission. Livingwood Windows Ltd accepts no liability arising from any party acting on information contained within this drawing. It is advised that assistance is sought from Livingwood windows Ltd regarding matters of an individual project.